



1718 Ex I/O

Catalog Numbers 1718-AENTR, 1718-IJ, 1718-OB2, 1718-OB2L, 1718-IBN8, 1718-IBN8B, 1718-IT4B, 1718-IR4B, 1718-IF4HB, 1718-CF4H, 1718-PSDC, 1718-A20, 1718-A10, 1718-CBL3, 1718-ARM, 1718-E4UBDE-1, 1718-E4UBDE-20, 1718-E4UBDE-40, 1718-E4UBDE-100, 1718-E4UBJM-2, 1718-E4UBJM-20, 1718-E4UBJM-40, 1718-E4UBJM-100



Allen-Bradley

by ROCKWELL AUTOMATION

User Manual

Original Instructions

Important User Information

Read this document and the documents listed in the additional resources section about installation, configuration, and operation of this equipment before you install, configure, operate, or maintain this product. Users are required to familiarize themselves with installation and wiring instructions in addition to requirements of all applicable codes, laws, and standards.

Activities including installation, adjustments, putting into service, use, assembly, disassembly, and maintenance are required to be carried out by suitably trained personnel in accordance with applicable code of practice.

If this equipment is used in a manner not specified by the manufacturer, the protection provided by the equipment may be impaired.

In no event will Rockwell Automation, Inc. be responsible or liable for indirect or consequential damages resulting from the use or application of this equipment.

The examples and diagrams in this manual are included solely for illustrative purposes. Because of the many variables and requirements associated with any particular installation, Rockwell Automation, Inc. cannot assume responsibility or liability for actual use based on the examples and diagrams.

No patent liability is assumed by Rockwell Automation, Inc. with respect to use of information, circuits, equipment, or software described in this manual.

Reproduction of the contents of this manual, in whole or in part, without written permission of Rockwell Automation, Inc., is prohibited

Throughout this manual, when necessary, we use notes to make you aware of safety considerations.



WARNING: Identifies information about practices or circumstances that can cause an explosion in a hazardous environment, which may lead to personal injury or death, property damage, or economic loss.



ATTENTION: Identifies information about practices or circumstances that can lead to personal injury or death, property damage, or economic loss. Attentions help you identify a hazard, avoid a hazard, and recognize the consequence.

IMPORTANT

Identifies information that is critical for successful application and understanding of the product.

Labels may also be on or inside the equipment to provide specific precautions.



SHOCK HAZARD: Labels may be on or inside the equipment, for example, a drive or motor, to alert people that dangerous voltage may be present.



BURN HAZARD: Labels may be on or inside the equipment, for example, a drive or motor, to alert people that surfaces may reach dangerous temperatures.



ARC FLASH HAZARD: Labels may be on or inside the equipment, for example, a motor control center, to alert people to potential Arc Flash. Arc Flash will cause severe injury or death. Wear proper Personal Protective Equipment (PPE). Follow ALL Regulatory requirements for safe work practices and for Personal Protective Equipment (PPE).

	Important User Information	2
Preface	Who Should Use This Manual	5
	Purpose of This Manual	5
	Additional Resources	5
	 Chapter 1	
Product Specifications	Introduction	7
	1718 Ex I/O Components	9
	1718 Ex I/O Components Overview	9
	Enclosures	9
	Enclosures for Use in Zone 1	10
	Chassis	10
	Function	10
	Design and Dimensions	11
	I/O Modules	13
	Analog Module Selection Guide	14
	Digital Output Module Selection Guide	15
	Design and Dimensions of the Modules	17
	Adapter	19
	Function	19
	Adapter Components	20
	Adapter Considerations	20
	EtherNet/IP Network	21
	Use the Module on a Device Level Ring Network	21
	1718-AENTR LCD Screen	22
	Protected Mode	25
	Enter and Exit Protected Mode	26
	Restrictions Imposed By Protected Mode	26
	Perform Tasks When Restricted	26
	Power Supply Module	28
	Placeholder Module	29
	Accessories	29
	Field Wiring	29
	Cables	31
	 Chapter 2	
Commissioning	Electrical Testing of Connections	33
	Testing and Addressing the EtherNet/IP Connection	33
	Configuration	33
	 Chapter 3	
Operation	Ownership	35
	Configure a 1718 Ex I/O System	35
	Connections	36
	Addressing with 1718 Ex I/O	36

	Chapter 4	
1718 Ex I/O HART Analog I/O Modules	HART Communication	40
	Integrated HART Networks	41
	HART-enabled I/O Modules	41
	Asset Management Software	41
	HART Device Info Tab	42
	Set Device Info (1718-IF4HB, 1718-CF4H).....	45
	HART Command Tab -	
	1718-IF4HB, 1718-CF4H.....	46
	Data in the Input Tags.....	46
	HART Dynamic Variables	47
	How the Module Automatically Collects Data	49
	Getting HART Data by Using CIP MSG	52
	HART Modules Used with Asset Management Software	52
	Considerations for Asset Management Systems	52
	Frequently Asked Questions.....	52
	 Appendix A	
Troubleshooting	Communication Errors.....	55
	Signal Faults	56
	 Appendix B	
Technical Data	Power Supply	57
	Mechanical Data	57
	Ambient Conditions	58
	 Appendix C	
Additional HART Protocol Information	Message Structure	60
	Master-slave Operation	60
	Multiple Master Operation.....	60
	Transaction Procedure.....	60
	Burst Mode	60
	Response Code and	
	Field Device Status	61
	HART PV, SV, TV, and FV Status	67
	 Appendix D	
Engineering Unit Code Numbers	Code Number Details	71

Read this preface to familiarize yourself with the rest of the manual. It provides information concerning:

- who should use this manual
- the purpose of this manual
- related documentation
- supporting information

Who Should Use This Manual

This manual is intended for trained and qualified personnel who are responsible for mounting, installation, commissioning, operation, maintenance, and disassembly of 1718 Ex I/O.

Purpose of This Manual

This manual provides information and describes the procedures that are used to install, wire, troubleshoot, and operate 1718 Ex I/O.

Additional Resources

These resources contain information about related products from Rockwell Automation.

Resource	Description
1718 Ex I/O Installation Instructions, publication 1718-IN001	Describes how to install and wire the 1718 Ex I/O input and output modules
1718 Ex I/O Technical Data, publication 1718-TD001	Provides specifications, wiring diagrams, and module block diagrams for 1718 Ex I/O
1718 Certification Bulletin, publication 1718-CT001	Provides 1718 Ex I/O certification information and links to control drawings.
Industrial Automation Wiring and Grounding Guidelines, publication 1770-4.1	Provides general guidelines for installing a Rockwell Automation industrial system.

You can view or download publications at <http://www.rockwellautomation.com/literature/>. For Release Notes and other publications specific to your module, search the catalog number of the module. To order paper copies of technical documentation, contact your local Allen-Bradley distributor or Rockwell Automation sales representative.

Notes:

Product Specifications

Topic	Page
Introduction	7
1718 Ex I/O Components	9
Enclosures	9
Chassis	10
I/O Modules	13
Adapter	19
Power Supply Module	28
Placeholder Module	29
Accessories	29

Introduction

Remote I/O systems, consisting of I/O modules, adapters, power supplies, and a chassis, form the interface for signals to be transmitted from the explosion hazardous area (Ex area), to the safe area (non-hazardous area). With appropriate enclosures, remote I/O systems can be installed in Gas-Ex areas of Zone 1. Using remote I/O, a wide range of digital and analog sensors and actuators can be connected to process control systems over a EtherNet/IP™. The adapter is the interface between the I/O modules on the chassis and the process control system. Power supplies are used to power the I/O modules and adapter.

IMPORTANT Requirements for equipment protection level Gb Components of the 1718 Ex I/O system may be installed and operated in Zone 1 only if they are installed in a surrounding enclosure that complies with a Gb equipment protection level.

This manual sets out how to work with the hardware. See the adapter and I/O modules for information on the configuration of the adapter and the I/O modules.

Table 1 - 1718 Ex I/O Modules

Type	Catalog Number	Description
Communication Adapter	1718-AENTR	Ex I/O EtherNet/IP Adapter
Digital input	1718-IJ	Ex I/O Frequency Counter
	1718-IBN8B	Ex I/O 8 Point Digital Input NAMUR Wide
	1718-IBN8	Ex I/O 8 Point Digital Input NAMUR

Type	Catalog Number	Description
Analog input	1718-IF4HB	Ex I/O 4 Channel HART Analog Input Wide
	1718-IR4B	Ex I/O 4 Channel RTD Input Wide
	1718-IT4B	Ex I/O 4 Channel Thermocouple Input Wide
Configurable analog input/output	1718-CF4H	Ex I/O 4 Channel HART Analog Configurable
Digital output	1718-OB2	Ex I/O 2 Point Digital Output 23V
	1718-OB2L	Ex I/O 2 Point Digital Output 16.5V
Power supply	1718-PSDC	Ex I/O DC Power Supply
Backplane	1718-A20	Ex I/O 20 Slot Chassis
	1718-A10	Ex I/O 10 Slot Chassis
Connection cable	1718-CBL3	Ex I/O Chassis Extension Cable 3 m
EtherNet/IP cable	1718-E4UBDE-1	M12-M12 E/IP cable, 1 m
	1718-E4UBDE-20	M12-M12 E/IP cable, 20 m
	1718-E4UBDE-40	M12-M12 E/IP cable, 40 m
	1718-E4UBDE-100	M12-M12 E/IP cable, 100 m
	1718-E4UBJM-2	M12-RJ45 E/IP cable, 2 m
	1718-E4UBJM-20	M12-RJ45 E/IP cable, 20 m
	1718-E4UBJM-40	M12-RJ45 E/IP cable, 40 m
	1718-E4UBJM-100	M12-RJ45 E/IP cable, 100 m
Placeholder	1718-ARM	Ex I/O Empty Slot Cover

1718 Ex I/O Components

1718 Ex I/O Components Overview

See the following graphic and table for the descriptions of different 1718 Ex I/O components:

Figure 1 - 1718 Ex I/O Components Overview

Stainless Steel Enclosure

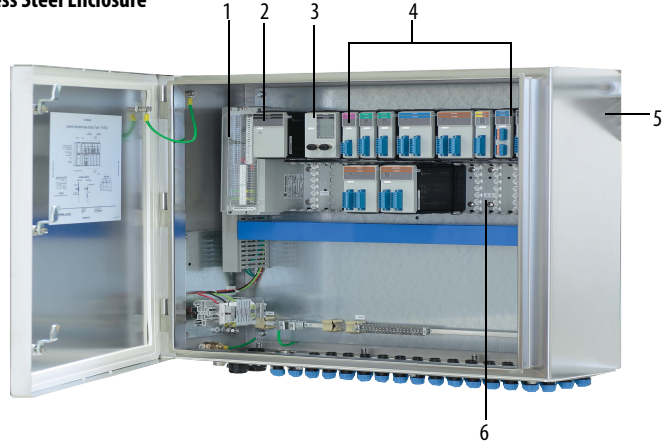

Plastic Enclosure

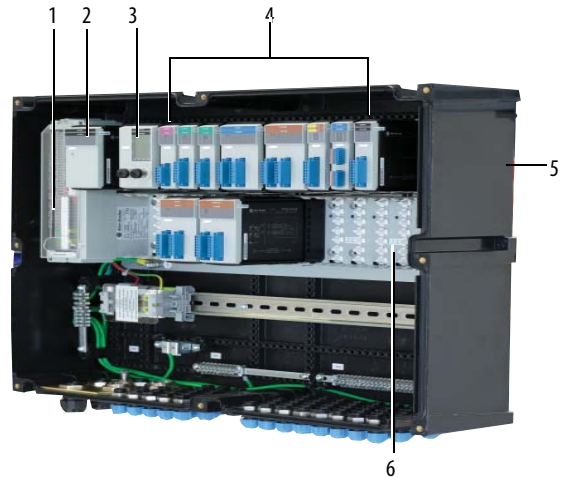

Table 2 - 1718 Ex I/O Components Overview

	Description		Description
1	Ex-e-terminals and IP30 cover	4	I/O modules
2	Power supply	5	Enclosure ⁽¹⁾
3	Adapter	6	Backplane

(1) The enclosure is a requirement for Zone 1 areas and is not part of the 1718 Ex I/O components. It is shown here for illustration purposes only.

Enclosures

Enclosures protect all electronic components against environmental influences and are an integral part of explosion protection. Enclosures are not part of the Ex I/O components. In order to meet zone 1 mounting requirements, you must use a certified enclosure, for example, ATEX for use in Europe.

Rockwell Automation partners with Pepperl+Fuchs for enclosure solutions. For more details on the enclosures from our partners, see publication [1718-PP002](#).

These enclosures are made of glass fiber reinforced polyester or stainless steel and are available in various versions. The enclosures contain chassis for the connection of modules. The modular concept allows multiple enclosures to be flanged together to create the required expansion level. Each enclosure contains Ex-e terminals for power. For safety, these are individually equipped with protective covers (IP30) and touch protection.

The enclosures are equipped with a rating plate listing all safety-relevant information, for example, type of ignition protection, temperature class, permissible ambient temperature and permissible power.

Enclosures for Use in Zone 1

Zone 1 explosion protection relates to:

- Responsibility
- Accountability
- Safety for life, health, and property
- Electrical safety

To choose an enclosure from an enclosure manufacturer, make sure that the manufacturer has adhered to regional certification directives, for example ATEX for use in Europe, submitted the enclosure for regional certification in accordance with applicable directives, such as ATEX directive 2014/34/EU, and received appropriate certification.

The enclosure manufacturer, the manufacturing facility, and the enclosure installer need respective certification in order to comply with regional Zone 1 standards, for example ATEX in Europe.

Chassis

Function

The modules are plugged into the chassis, which in turn is installed in a certified enclosure. The chassis supplies the modules with energy and provides internal wiring.

Any I/O module can be inserted into any I/O slot, enabling a mixture of I/O functions in one enclosure. Power supplies and adapters are installed in their reserved slots. These are mechanically coded to avoid confusion.



WARNING: Risk of death as a result of using a damaged or tampered chassis.

Using a defective or tampered chassis means that explosion protection can no longer be guaranteed.

- Do not use a damaged chassis.
- The chassis must not be tampered with.
- In the event of a fault, the chassis must always be replaced with an original chassis from Rockwell Automation.

Figure 2 - Overview of Chassis

Catalog Number	Description
1718-A20	20 slots
	Redundant power supply
1718-A10	10 slots
	Redundant power supply

Design and Dimensions

The 1718-A20 chassis acts as a base chassis and can connect, by an extension cable, to either a 1718-A20 or a 1718-A10 chassis to create an extended chassis. The following matrix shows the allowable base and extension chassis combinations.

Base	Extension	
	1718-A10	1718-A20
1718-A10	–	–
1718-A20	X	X

1718-A20

- Slots for an adapter and 2 power supplies
- Slots for max. 20 narrow or 10 wide I/O modules

Figure 3 - 1718-A20 Dimensions

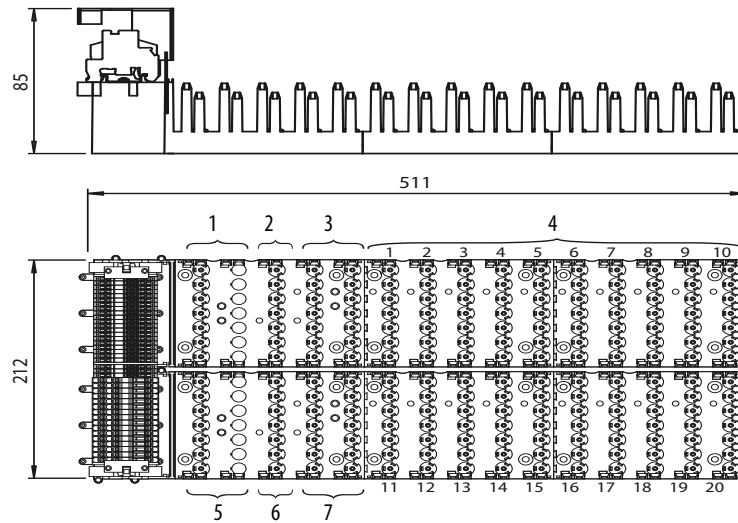

Table 3 - 1718-A20 Dimension Descriptions

Number	Description
1	Power supply
2	Reserved
3	Adapter when used as a base chassis Empty slot when used as an extension chassis
4	Slots for 20 narrow or 10 wide I/O modules
5	Redundant power supply
6	Reserved
7	Reserved

1718-A10

- Slots for an adapter and 2 power supplies
- Slots for max. 10 narrow or 5 wide I/O modules

Figure 4 - 1718-A10 Dimensions

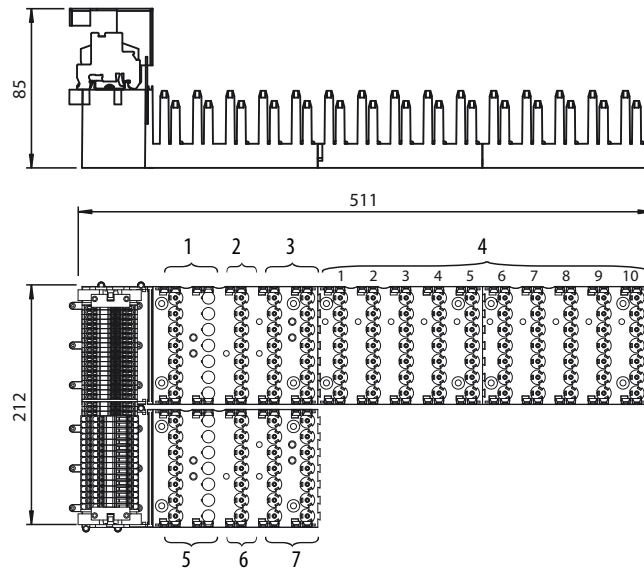

Table 4 - 1718-A10 Dimension Descriptions

Number	Description
1	Power supply
2	Reserved
3	Adapter when used as a base chassis Empty slot when used as an extension chassis
4	Slots for 10 narrow or 5 wide I/O modules
5	Redundant power supply
6	Reserved
7	Reserved

I/O Modules

I/O modules are used to modify signals between field devices in explosion-hazardous areas and controllers or control systems in the safe area. The slots for the I/O modules on the chassis are equal, so you can use I/O modules with different functions next to each other.



The status of each channel is displayed using an LED indicator for clear information about the status of the field device directly on the device itself. For more information about the status LED indicators, see the respective datasheets for the modules.

When modules are replaced, the new module automatically adopts the settings of its predecessor. This prevents errors when replacing modules.

The 4-channel configurable input/output module processes analog inputs or outputs depending on the setting.

Analog Module Selection Guide

- **1718-CF4H**

The 1718-CF4H is a configurable input/output module. The module can be configured as either analog input or analog output. As an analog input device, it feeds 2-wire transmitters. As an analog output device, it can drive proportional valves, I/P converters, or local indicators. Note that the module is not configurable by channel. The 1718-CF4H offers 12-bit resolution.

- **1718-IF4HB**

The 1718-IF4HB is an analog input module that feeds 2- and 3-wire transmitters. Active signals from separately powered field devices and 4-wire transmitters can also be connected. The 1718-IF4HB offers 12-bit resolution.

Table 5 - Transmitter compatibility for the 1718-IF4HB and 1718-CF4H analog modules

Devices	1718-IF4HB		1718-CF4H	
	HART	Without HART	HART	Without HART
2-wire	X	X	X	X
3-wire	–	X	–	–
4-wire	–	X	–	–

- **1718-IR4B**

The 1718-IR4B is an RTD converter that accepts 2-, 3-, 4-wire RTD signals and slide-wire sensors from the field. The 1718-IR4B offers 12-bit resolution.

- **1718-IT4B**

The 1718-IT4B is a thermocouple converter that accepts thermocouple or mV signals from the hazardous area and offers 12-bit resolution. The 1718-IT4B I/O module is equipped with an internal cold junction. However, it can be used with an external cold junction. Using the Add-on Profile, you can set the cold junction compensation mode to either Local (internal) or Remote (external). For more information, see the Add-on Profile help topic for the 1718-IT4B module.

A note on Analog Module Resolution:

When configuring the module with the Add-on Profile, the user can select the sensor type and expected measuring range. Selecting the appropriate measuring range configures the module to deliver the best resolution for the range elected. For more information, see the Add-on Profile help topic for the 1718 analog modules.

Digital Output Module Selection Guide

There are two digital output modules available to support different power requirements of connected devices: 1718-OB2 and 1718-OB2L.

The digital output modules can be configured to use the two channels separately and independently or to combine the two outputs to one logical output with more power. When the module is operating in the latter configuration, referred to as "Parallel," the LED labeled "M" on the front of the 1718-OB2 or 1718-OB2L will be illuminated. In the Add-on Profile, the two modes are referred to as "Low Current, Two Points," and, "High Current, One Point."

When the module is used with two separate channels, the 1718_19_DO2_Diag:C:0 configuration assembly should be used for the configuration data. In this case, the 1718_19_DO2:O:0 has to be used as output assembly and the 1718_19_DO2_Diag:I:0 has to be used as input assembly for read back and status information.

When the module is used in Parallel mode, with the two outputs combined to one logical channel, the 1718_19_DO1_Diag:C:0 configuration assembly should be used for the configuration data. In this case, the 1718_19_DO1:O:0 has to be used as output assembly and the 1718_19_DO1_Diag:I:0 has to be used as input assembly for read back and status information.

The following table lists some of the compatible solenoids for the 1718-OB2 and 1718-OB2L digital output modules:

Manufacturer	Solenoid	1718-OB2	1718-OB2 Parallel	1718-OB2L	1718-OB2L Parallel
ASCO	IS-M12-I	0...>300 Ohm	0...>300 Ohm	0...275 Ohm	0...>300 Ohm
ASCO	Series 195	0...120 Ohm			
ASCO	Series 302 (LP1 "12V" 0.5 W)	0...67 Ohm	0...196 Ohm		
ASCO	Series 302 (LP1 "24V" 0.25 W)	0...194 Ohm	0...>300 Ohm		
ASCO	Series 302 (LP1 "24V" 0.5 W)		0...84 Ohm		
ASCO	Series 622 (Spool Valve Island)	0...194 Ohm	0...>300 Ohm		
ASCO	Series 630: Piezotronic 12V (12 mW Version)	0...>300 Ohm		0...>300 Ohm	
ASCO	Series 630: Piezotronic 12V (32 mW Version)	0...212 Ohm		0...>300 Ohm	
ASCO	Series 630: Piezotronic 6V (3 mW Version)	0...>300 Ohm		0...>300 Ohm	
ASCO	Series 630: Piezotronic 8V (22 mW Version)	0...42 Ohm		0...169 Ohm	
ASCO	Series LIWSLI	0...70 Ohm	0...199 Ohm		0...59 Ohm

Manufacturer	Solenoid	1718-OB2	1718-OB2 Parallel	1718-OB2L	1718-OB2L Parallel
ASCO	Series LISC	0...25 Ohm	0...154 Ohm		
ASCO	Series NFIS WSNFIS	0...> 300 Ohm	0...> 300 Ohm	0...299 Ohm	0...> 300 Ohm
ASCO	Series WPIS WSIS	0...> 300 Ohm	0...> 300 Ohm	0...> 300 Ohm	0...> 300 Ohm
ATOS	OW-18/H		0...51 Ohm		0...14 Ohm
BC	BC-x.8.12.25			0...28 Ohm	0...93 Ohm
BC	BC-x.8.12.30				0...67 Ohm
BC	BC-x.8.12.35				0...48 Ohm
BC	BC-x.8.12.40				0...34 Ohm
BC	BC-x.8.12.45				0...23 Ohm
BC	BC-x.8.12.50				0...14 Ohm
Buerkert	Coil AC 10 EEXi für Ventile:0590EEXi, 6014EEXi, 6518EEXi, 6519EEXi	0...149 Ohm			
Buerkert	Coil AC21 EEXi für Ventile:0450EEXi, 5470EEXi, 6106EEXi, 6516EEXi, 6517EEXi	0...175 Ohm			
Buerkert	Coil G1 642735 EEXi;6104 EEXi, 6510 EEXi, 6511 EEXi, 6524 EEXi,6525EEXi, 8631EEXi	0...164 Ohm		0...67 Ohm	
FAS	Microsol_12V_T4_85		0...108 Ohm		0...12 Ohm
FAS	Microsol_12V_T5_50		0...108 Ohm		0...12 Ohm
Festo	CPV10-EX-VI	0...116 Ohm			
Festo	MFVH* (Coil: GBXE 022*)		0...206 Ohm	0...53 Ohm	0...118 Ohm
Herion	2010...2014				0...74 Ohm
Herion	2050	0...197 Ohm	0...300 Ohm	0...127 Ohm	0...192 Ohm
Herion	2051	0...230 Ohm	0...300 Ohm	0...86 Ohm	0...152 Ohm
Herion	2052	0...213 Ohm	0...300 Ohm		0...22 Ohm
Herion	2053	0...50 Ohm	0...179 Ohm		
Herion	2080/2082	0...300 Ohm		0...300 Ohm	
Herion	2081/2082	0...300 Ohm		0...300 Ohm	
Herion	2084	0...300 Ohm		0...300 Ohm	
Hoerbiger	PN61	0...300 Ohm	0...300 Ohm	0...300 Ohm	0...300 Ohm
Hoerbiger	PN65	0...300 Ohm	0...300 Ohm	0...300 Ohm	0...300 Ohm
Honeywell-Lucifer	Coil mit 295 Ohm	0...121 Ohm			
KVAutomation	KVEX131	0...113 Ohm	0...242 Ohm	0...55 Ohm	0...120 Ohm
Norgren	2003	0...242 Ohm			
Norgren	Coil 06129(2086)	0...> 300 Ohm			
Parker	488650.01/03_488660.01/03_488670.01/03	0...139 Ohm			
Parker	492965.01/02	0...242 Ohm			
Parker	495910	0...186 Ohm			
Parker	495910N7	0...177 Ohm			
RGS	Coil EP100/ia	0...91 Ohm	0...220 Ohm	0...15 Ohm	0...80 Ohm
Samson	3701-11	0...> 300 Ohm			
Samson	3701-12	0...> 300 Ohm			
Samson	3701-13	0...> 300 Ohm			
Samson	3775-13	0...> 300 Ohm			
Samson	3962-13	0...> 300 Ohm			
Samson	3962-17	0...> 300 Ohm			

Manufacturer	Solenoid	1718-OB2	1718-OB2 Parallel	1718-OB2L	1718-OB2L Parallel
Samson	3963-12	0...> 300 Ohm			
Samson	3963-13	0...> 300 Ohm			
Samson	3963-17	0...> 300 Ohm			
Samson	3967-1	0...> 300 Ohm			
Samson	3967-2	0...> 300 Ohm			
Samson	3967-3	0...> 300 Ohm			
Seitz	PV 12F73 Ci oh	0...> 300 Ohm		0...> 300 Ohm	
Seitz	PV 12F73 Xi oh	0...> 300 Ohm		0...> 300 Ohm	
Seitz	PV 12F73 Xi oh 2	0...> 300 Ohm		0...> 300 Ohm	
Seitz	Typ 11G52 Art.-Nr.121 113 01	0...242 Ohm			
SMC	52-SY5000	0...63 Ohm		0...19 Ohm	
SMC	52-SY7000	0...63 Ohm		0...19 Ohm	
SMC	52-SY9000	0...63 Ohm		0...19 Ohm	
Teletron	Coil L (12...24 V)	0...> 300 Ohm			
Wandfluh	ISI 4401-03				0...17 Ohm

Design and Dimensions of the Modules

The 1718 Ex I/O system is designed in such a way that each I/O module can be connected to any slot in the I/O section of the chassis. The slots on the chassis are limited so the total number of I/O that the chassis base can accommodate varies depending on the combination of narrow and wide I/O modules. For example, a base chassis can accommodate max. 20 narrow or 10 wide I/O modules.

Power supplies and adapters are assigned to fixed slots. To avoid confusion, these are mechanically coded so that they only fit in their respective slots. Adapters and power supplies are always wide modules.

Both the I/O modules and the adapters and power supplies are equipped with LEDs on the front that display the device status.

The I/O modules have connections on the front to which the relevant field devices are connected. On the back of the I/O modules there is mechanical coding that prevents an I/O module from being accidentally inserted into a slot that is intended for an adapter or a power supply.



WARNING: Explosion hazard as a result of removing mechanical coding.

Removing the mechanical coding means explosion protection can no longer be guaranteed.

Never remove the mechanical coding from the module.

Figure 5 - Narrow Modules

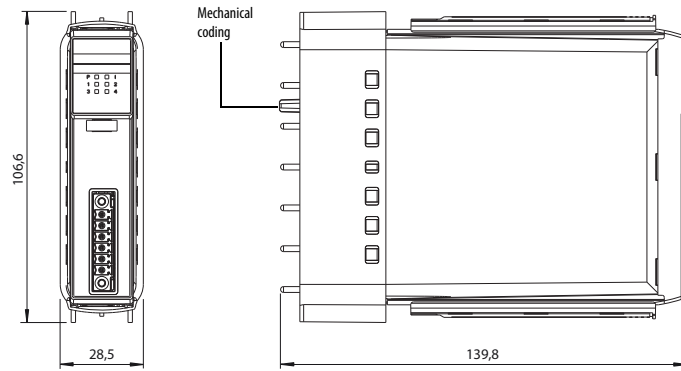
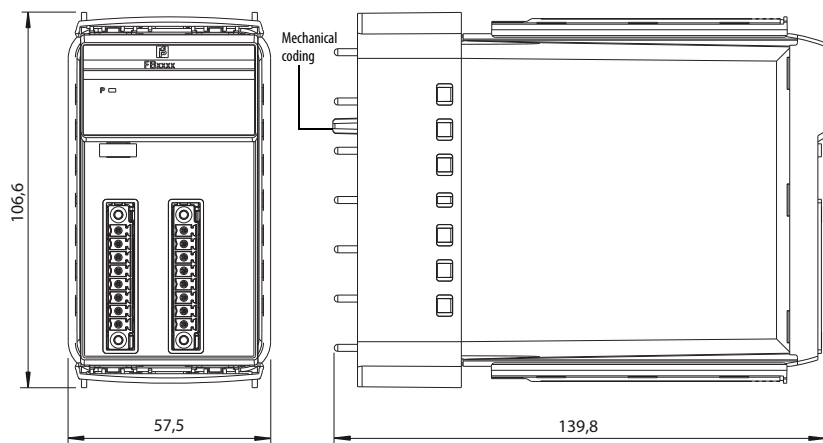

Figure 6 - Wide modules



Adapter

Adapters form the interface between the I/O modules and the process control system using EtherNet/IP. The adapter can be operated directly using the touch screen on the front, meaning it can be configured directly in the field. In addition, the device status displays using the four LEDs below the touch screen.

The two Ethernet interfaces on the front connect the device to the Ethernet network.



WARNING: Explosion hazard in Zone 1.

When pulling out an M12 connector in Zone 1, a spark may form that ignites an explosive mixture.

- Do not pull out M12 connectors in potentially explosive atmospheres.
 - Use only original Rockwell Automation cables with the 1718-AENTR.
-



WARNING: Property damage due to incorrect terminal assignment.

Incorrect terminal assignment and incorrectly positioned plug-in jumpers can cause damage to the adapter.

- Ensure that the terminal assignment of the adapter is correct. See the chassis information in the 1718 Ex I/O Installation Instructions, publication [1718-IN001](#). Terminals 39 and 40 must be inserted.
 - Ensure that the plug-in jumper is correctly positioned. See the chassis information in the 1718 Ex I/O Installation Instructions, publication [1718-IN001](#).
-

Function

An adapter can control up to 40 I/O modules and transfers their signals across EtherNet/IP. The adapter converts the protocol of the bus that is integrated in the backplane to the protocol of EtherNet/IP.

IMPORTANT The total power consumption of the selected modules on each rack must not exceed the maximum power that is supplied by the selected power supply module configuration.

Adapter Components

The following figure identifies the components of the 1718-AENTR adapter.



	Description		Description
1	LCD screen	7	LINK2 LED (Link Status Port 2)
2	Up navigation	8	LINK1 LED (Link Status Port 1)
3	Down navigation	9	NET LED (Network Status)
4	OK LED (Adapter Status)	10	Enter/OK
5	Ethernet Port 1	11	Cancel/Back
6	Ethernet Port 2		

Adapter Considerations



ATTENTION: To prevent damage to the 1718-AENTR adapter, connect all Ethernet cables before the adapter is powered on and avoid disconnecting Ethernet cables while the adapter is online.

Determine Compatibility

The 1718-AENTR Add-on Profile must be used with one of the following:

- Studio 5000® software, version 24 or later
- RSLinx® software, version 3.74 or later

Add-on Profile Considerations

- The adapter can be configured using the Add-on Profile. For more information, see the Add-on Profile help.
- In the Add-on Profile display, on the Module Info page, the Internal State of the adapter shows Run mode regardless of the status of the controller (Program mode or Run mode).

- Modules can only be reset by inhibiting the module through the Add-on Profile.
- The 1718-AENTR adapter does not support half-duplex on the Ethernet ports.

EtherNet/IP Network

EtherNet/IP is a network suitable for use in industrial environment and time-critical applications. EtherNet/IP uses standard Ethernet and TCP/IP and UDP technologies and an open application layer protocol that is called the Common Industrial Protocol (CIP). The 1718-AENTR connects Ex I/O to EtherNet/IP enabled controllers such as ControlLogix® or CompactLogix™.

To connect EtherNet/IP in Zone 1 areas, reference the appropriate wiring standards for hazardous areas:

- For Zone 1, follow IEC 60079-14

Use the Module on a Device Level Ring Network

A Device Level Ring (DLR) network is a single-fault-tolerant ring network that is intended for the interconnection of automation devices without the need for additional switches. The ring topology offers these advantages:

- Media redundancy
- Fast network fault detection and reconfiguration
- Resiliency of a single-fault tolerant network

One DLR network can support as many as 50 nodes. A DLR network supports copper connections [maximum of 100 m (328 ft)], fiber-optic connections [maximum of 2 km (1.24 mi)], or a mix of copper and fiber.

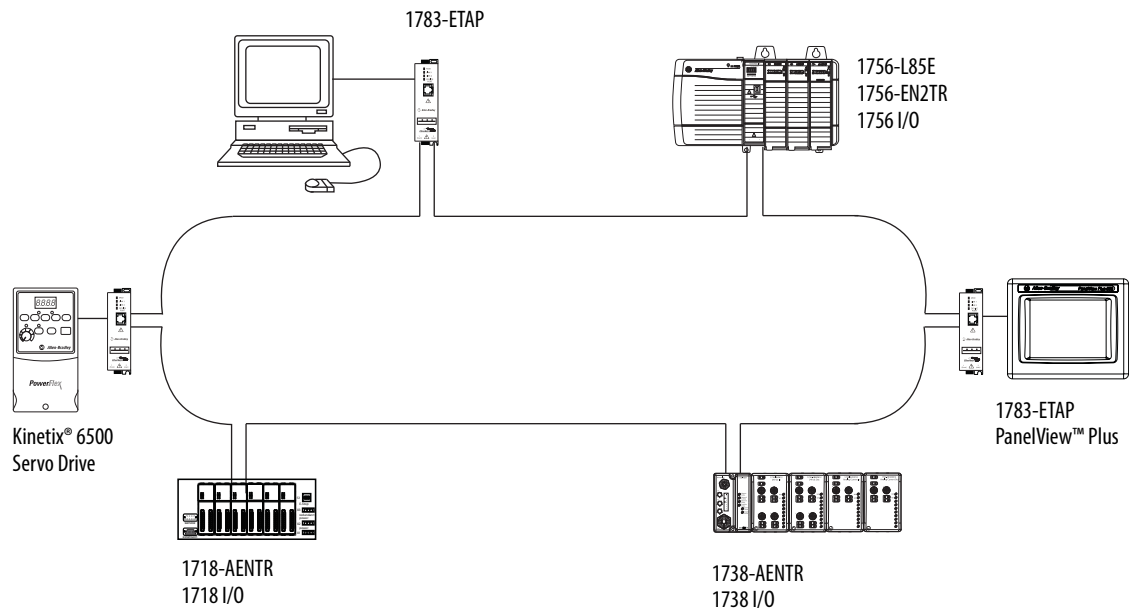

For more information about EtherNet/IP, refer to EtherNet/IP Embedded Switch Technology Application Guide, publication ENET-AP005.

1718-AENTR LCD Screen

The 1718-AENTR offers an LCD screen with several menus displaying system information.

On any screen, the Up/Down navigation arrows allow the user to scroll through the list of information or options, Enter/OK(↵) selects a chosen option, and Cancel/Back (X) returns the user to the previous screen.

Note that the LCD is a 4 quadrant touch screen. Pressing in the upper left quadrant selects the Up navigation, pressing the lower left quadrant selects the Down navigation, pressing the upper right quadrant selects Cancel/Back, and pressing the lower right quadrant selects Enter/OK. To prevent damage to the LCD screen, do not use a sharp or pointed object to navigate the menus.

Start Screen

The Start screen also displays the device status including any channels with error messages and any devices plugged into the backplane but not configured. The Start screen displays the current IP address and firmware revision.



Main Menu

The Main Menu offers the option to select from the following screens: Diagnostic, Parameter, or Service.

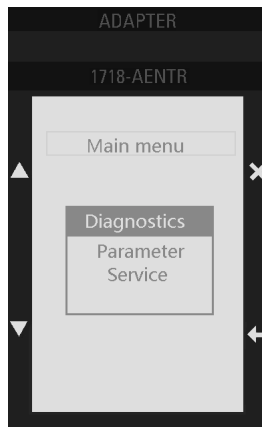

- Diagnosis** - The Diagnosis screen allows you to view diagnostic information for a given module. On the left side of the screen, the user will see a list of channels. The top of the screen displays the selected device type and slot.

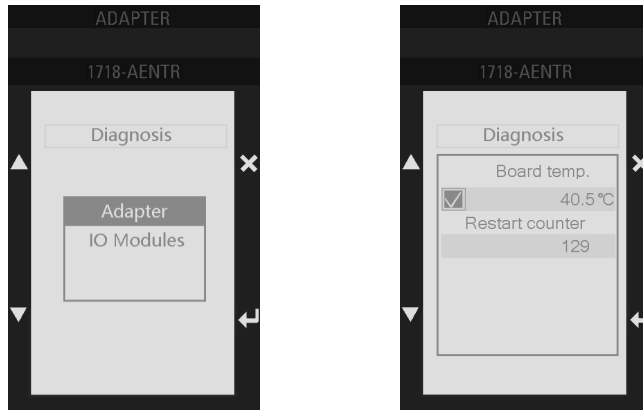

For analog modules, the screen displays the current channel that is selected, value in engineering units, channel status (indicates "OK", indicates "ERROR") and a text message for diagnostic information.

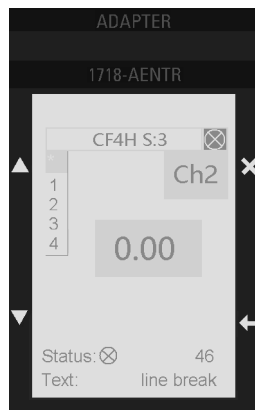

For digital modules, the screen displays diagnostic information in tabular form where the column labeled "C" indicates the channel number, "V" indicates the current value, "S" indicates channel status (indicates "OK", indicates "ERROR"), And "Message" Indicates the text message for diagnostic information.

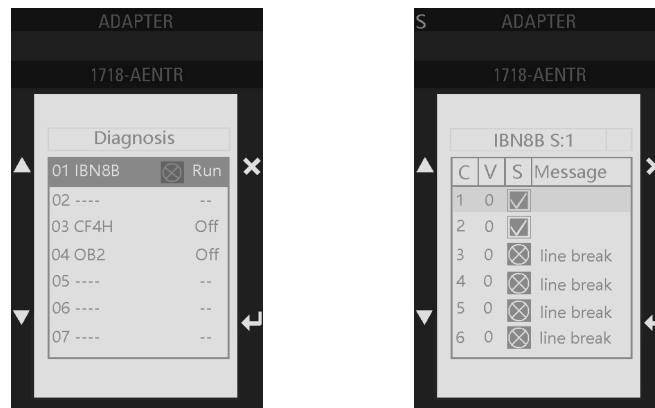

- **Parameter** - The Parameter screen allows the user to view and select EtherNet/IP parameters including DHCP (On/Off), IP address, Subnet Mask, and Default Gateway.

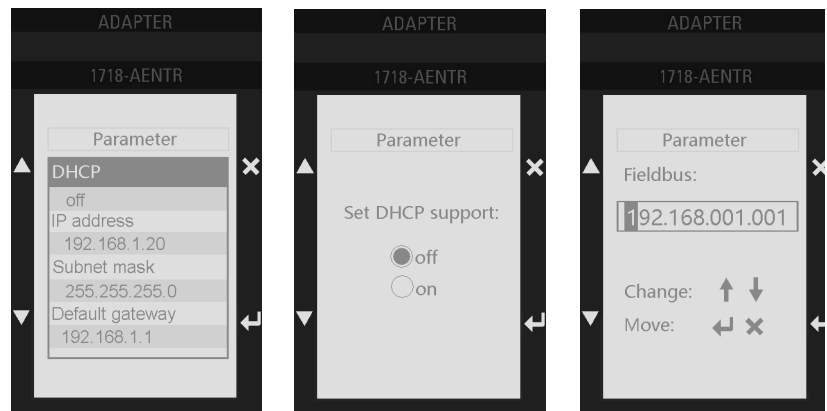

- **Service** - The Service screen displays basic system information including software version, Uboot version, Preloader version, Sysid time stamp, current date/time, and Uptime (shown as the time elapsed since previous boot).



Protected Mode

Protected Mode is a state where the device is operational, but has implemented defenses against disruptive changes that would take the product out of service for the process.

Protected Mode is a security enhancement that is automatically triggered as soon as one of the following occur:

- The adapter bridges I/O connections.
- The adapter is a target of I/O connections.

This security enhancement occurs on the I/O module level and helps prevent unauthorized configuration changes that can affect system behavior and cause unintended and unforeseen changes.

Enter and Exit Protected Mode

The adapter enters Protected Mode as soon as I/O connections are established through or to the adapter (status connection). The adapter exits Protected Mode as soon as all I/O connections through or to the adapter (status connection) are stopped.

Restrictions Imposed By Protected Mode

Protected Mode prevents access to services that are not required after the device is configured and in normal operation. Protected Mode disables features that can make the device vulnerable to disruptive actions. By doing so, Protected Mode helps to reduce the attack surface.

When it is in Protected Mode, the adapter prevents execution of the following tasks:

- Changing Ethernet configuration settings, such as port speed.
- Changing IP settings, such as IP address, mask, and DHCP mode.
- Updating the adapter firmware revision.
- Disabling or re-enabling external product ports.
- Performing remote adapter resets.

Perform Tasks When Restricted

If the adapter is in Protected Mode and you attempt to perform any of the restricted tasks, you are alerted that such a task cannot be performed because the adapter is in Protected Mode.

The following are example alerts that result from an attempt to set IP values on the adapter when the adapter is in Protected Mode:

IMPORTANT Protected Mode is not configurable.

- Studio 5000 Logix Designer® application

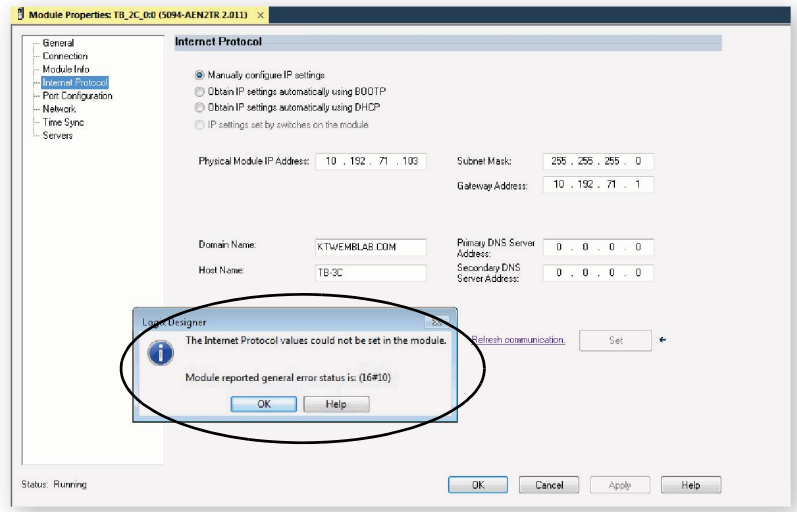

- RSLinx software

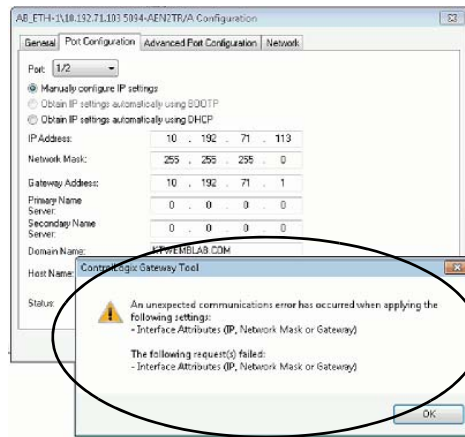

If the adapter is not in Protected Mode, the adapter does not reject attempts to perform the tasks that are described previously.

For example, after the adapter is initially powered up, but no I/O connections are established yet, the adapter is not in Protected Mode.

TIP If the adapter enters Protected Mode each time the adapter powers up, check application controllers to determine if there are active I/O connections that are opened through the adapter.

Power Supply Module

The power supplies provide power to all components of the remote I/O. The slots for adapters are mechanically coded on the chassis and marked accordingly.



One power supply module consumes up to 39 W. Note that the power dissipation is approximately 4.7 W at 100% load and 3.8 W at 50% load of the power consumption.

Both 1718-A10 and 1718-A20 chassis have slots for 2 power supply modules – 1 for the primary supply module and 1 for the redundant power supply module. This second power supply module is purely for redundancy purposes, and does not provide additional power to support the power supply consumption requirements of all the modules on the chassis.

The Integrated Architecture® Builder includes a power consumption calculator to support determining whether the chassis has reached maximum power consumption based on the combination of modules on the chassis:

Catalog	Catalog Description	Power Consumption (W)	Power Dissipation (W)
1718-AENTR	Ex I/O EtherNet/IP Adapter	4.40	4.40
1718-CF4H	Ex I/O 4 Channel HART Analog Configurable	3.00	2.00
1718-IF4HB	Ex I/O 4 Channel HART Analog Input Wide	3.00	2.00
1718-IR4B	Ex I/O 4 Channel RTD Input	0.40	0.40
1718-IT4B	Ex I/O 4 Channel Thermocouple Input	0.90	0.90
1718-IBN8B	Ex I/O 8 Point Digital Input NAMUR Wide	1.00	1.00
1718-IBN8	Ex I/O 8 Point Digital Input NAMUR	1.50	1.50
1718-OB2	Ex I/O 2 Point Digital Output 23V	3.00	2.00
1718-OB2L	Ex I/O 2 Point Digital Output 16.5V	3.00	2.00
1718-IJ	Ex I/O Frequency Counter	0.70	0.70
1718-PSDC	Ex I/O DC Power Supply	Depends on Module Load	Depends on Module Load

Placeholder Module

Placeholder modules keep non-wired field circuits in position. This module has no electrical connection.



Accessories

Field Wiring

The following accessories are available for field wiring.

Terminal Blocks

Terminal blocks are wired to the field devices, attached to the front sockets of the I/O modules, and tightened using the screws. Terminal blocks can come in the form of side screw terminals, front screw terminals, or spring terminals. All versions are available in blue, and to be used only for intrinsically safe circuits.

- Side screw terminals
 - 1719-TB6, 1719-TB8, 1719-TB8x2
- Front screw terminals
 - 1719-TB6F, 1719-TB8F, 1719-TB8x2F
- Spring terminals
 - 1719-TB6S, 1719-TB8S, 1719-TB8Sx2, 1719-TB8x2SA

Figure 7 - Side Screw Terminal Dimensions

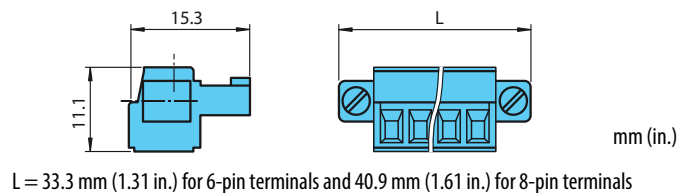

Figure 8 - Front Screw terminal Dimensions

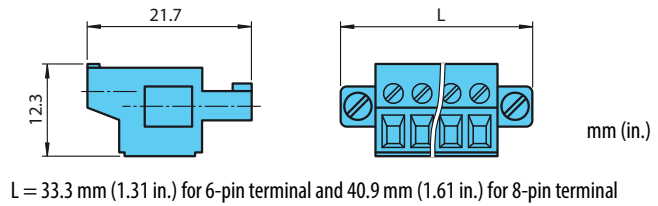
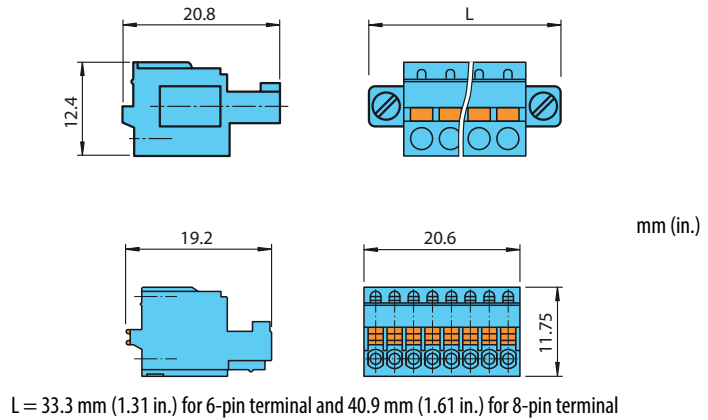

Figure 9 - Spring Terminal Dimensions



TIP The spring terminal for the 1718-IBN8 I/O module is only inserted and not screwed in.

Catalog	Catalog Description	Compatible Spring Terminal	Compatible Screw Terminal
1718-CF4H	Ex I/O 4 Channel HART Analog Configurable	1719-TB8S	1719-TB8, 1719-TB8F
1718-IF4HB	Ex I/O 4 Channel HART Analog Input Wide	1719-TB8Sx2	1719-TB8x2, 1719-TB8x2F
1718-IR4B	Ex I/O 4 Channel RTD Input	1719-TB8Sx2	1719-TB8x2, 1719-TB8x2F
1718-IT4B	Ex I/O 4 Channel Thermocouple Input	1719-TB8Sx2	1719-TB8x2, 1719-TB8x2F
1718-IBN8B	Ex I/O 8 Point Digital Input NAMUR Wide	1719-TB8Sx2	1719-TB8x2, 1719-TB8x2F
1718-IBN8	Ex I/O 8 Point Digital Input NAMUR	1719-TB8x2SA	—
1718-OB2	Ex I/O 2 Point Digital Output 23V	1719-TB8S	1719-TB8, 1719-TB8F
1718-OB2L	Ex I/O 2 Point Digital Output 16.5V	1719-TB8S	1719-TB8, 1719-TB8F
1718-IJ	Ex I/O Frequency Counter	1719-TB6S	1719-TB6, 1719-TB6F
1718-ARM	Ex I/O Empty Slot Cover	1719-TB8S	1719-TB8, 1719-TB8F

Coding pins

Coding pins provide a unique assignment between I/O modules and terminal blocks or the associated field devices. To do this, the coding pins are pushed into the grooves provided in the front sockets of the I/O modules. This prevents terminal blocks from being accidentally plugged into another I/O module

Use the 1719-CP coding pins for the following terminal blocks: 1719-TB6, 1719-TB6S, 1719-TB8, 1719-TB8S, 1719-TB8Sx2, 1719-TB8x2, 1719-TB6F, 1719-TB8F, 1719-TB8x2F.



WARNING: Risk of confusing device connections.

When coding the front sockets of the I/O modules, ensure that the codes are mutually exclusive. Otherwise there is the danger of incorrect mapping between devices and circuits in explosion-hazardous areas.

Figure 10 - 1719-CP coding pins

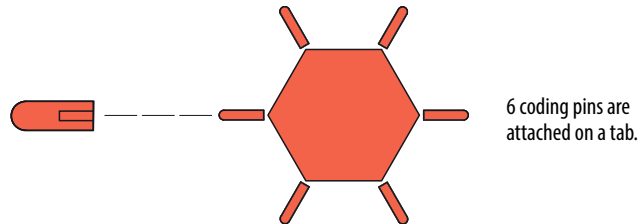

IMPORTANT Coding pins are sold as accessory bags that contain 120 pins.
1 bag = 120 pins (6 pins x 20)

For more information and examples of how to use the 1719-CP coding pins, see 1718 Ex I/O Installation Instructions, publication [1718-IN001](#).

Cables



WARNING: Explosion hazard through use of incorrect cables.

The use of incorrect cables in a potentially explosive atmosphere can create sparks that can ignite the surrounding atmosphere.

Cable for Chassis

The following table shows an overview of possible cables. Cables establish a local connection between a base chassis and an extension chassis. If a base chassis is extended with an extension chassis with additional I/O modules and power supplies, the chassis cable ensures data exchange between the adapters on the base chassis and the I/O modules on the extension chassis. The length of the chassis cable is 3 m.

Table 6 - Overview of Cables

Catalog Number	Description
1718-CBL3	Ex I/O Chassis Extension Cable, 3 m

Cables for Adapters

Adapters are equipped with M12 threaded plugs in Ex-e protection. The cable connects the adapter to the EtherNet/IP bus.

The following cables connect other adapters to the EtherNet/IP bus and also come with Ex-e protection. Only these cables can be used for the installation

Table 7 - Overview of Cables

Catalog Number	Description
1718-E4UBDE-1	M12-M12 E/IP cable, 1 m
1718-E4UBDE-20	M12-M12 E/IP cable, 20 m
1718-E4UBDE-40	M12-M12 E/IP cable, 40 m
1718-E4UBDE-100	M12-M12 E/IP cable, 100 m
1718-E4UBJM-2	M12-RJ45 E/IP cable, 2 m
1718-E4UBJM-20	M12-RJ45 E/IP cable, 20 m
1718-E4UBJM-40	M12-RJ45 E/IP cable, 40 m
1718-E4UBJM-100	M12-RJ45 E/IP cable, 100 m

Commissioning

Topic	Page
Electrical Testing of Connections	33
Configuration	33

Electrical Testing of Connections

Make sure that the plugs have been properly fitted to the EtherNet/IP RJ45 ports.

For more information, see EtherNet/IP Connection section of the 1718 Ex I/O Installation Instructions, publication [1718-IN001](#).

Testing and Addressing the EtherNet/IP Connection



WARNING: Risk of explosion

When taking measurements in hazardous areas, there is a risk of explosion from sparks forming.

Take measurements on the terminal connections of a distributed I/O station, with a hot work permit only, in other words when there is no potentially explosive atmosphere.

For information about testing and addressing of EtherNet/IP modules, refer to the EtherNet/IP Adapter User Manual, publication [ENET-UM001](#).

If you have not installed the Rockwell Software® BOOTP-DHCP Server for setting the network IP address, you can download and install it from: <http://www.software.rockwell.com/download/comms/rsnetworkx/bootp-dhcp%20server%202.3.2.zip>.

Configuration

The entire distributed I/O station is configured in the Add-on Profile:

1. Add a network card to the project (if needed).
2. Add a 1718 adapter to the project. Enable the status connection if diagnostics are needed.
3. Add I/O modules on the 1718 bus.

4. Set the configuration as needed (on the Points tab for digital modules and the Channels tab for analog modules).

For more information, see the Add-on Profile Help.

Operation

During operation, you can access up-to-date measured values and diagnostic information for the I/O modules through the adapter. For more information, see the help topic for the adapter.

In addition, you can read off basic information about supply and communication from the light-emitting diode (LEDs) on the I/O modules and adapters. For more information about the LEDs, refer to the technical data sheets for the I/O modules and the adapter.



ATTENTION: I/O modules and power supplies can be removed and inserted under power (RIUP) as the connections at the chassis use Ex d protection.

Ownership

Every I/O module in a Logix control system must be owned by a controller, also known as the owner-controller. When the 1718 Ex I/O modules are used in a Logix control system, the owner-controller performs the following:

- Stores configuration data for every module that it owns.
- Can reside in a location that differs from the 1718 Ex I/O.
- Sends the I/O module configuration data to define module behavior and begin operation in the control system.

Each 1718 Ex I/O module must continuously maintain communication with its owner-controller during normal operation. The 1718 Ex I/O modules are limited to one owner-controller that performs the functions that are listed previously. Other controllers can establish Listen-Only connections to the 1718 Ex I/O modules. If a controller uses a Listen-Only connection, the connection must use the Multicast option.

Configure a 1718 Ex I/O System

You must create a Studio 5000 Logix Designer® application project for the Logix controller that owns the 1718 Ex I/O module. The project includes module configuration data for the 1718 Ex I/O modules. The Logix Designer application transfers the project to the owner-controller during the program download. Data is then transferred to the 1718 Ex I/O modules over the EtherNet/IP network. The 1718 Ex I/O modules can operate immediately after receiving the configuration data.

Connections

During module configuration, you must define the module. Among the Module Definition parameters, you must choose a connection type for the module. A connection is a real-time data transfer link between the owner-controller and the module that occupies the slot that the configuration references.

When you download module configuration to a controller, the controller attempts to establish a connection to each module in the configuration.

For information on individual module configuration, refer to the Add-on Profile help file.

Addressing with 1718 Ex I/O

When manually configuring 1718 Ex I/O, it is important to note the slot numbering sequence.

In general, the following rules must be considered:

- The I/O modules can be placed in any sequence on the backplane. Single-width and dual-width modules can be mixed in any sequence on the backplane as well.
- A single-width module occupies one slot on the backplane.
- A dual-width module occupies two slots on the backplane, which is consistent with what is displayed in the Studio 5000® or RSLinx® I/O tree.
- There can be empty slots on the backplane. When an empty slot exists, the slot maintains its address but is left vacant. If a slot is left empty or if a 1718-ARM placeholder is mounted, the slot does not appear in the I/O tree, and is available for a module to be mounted to this slot later, if necessary.
- When using either the 1718-A10 or the 1718-A20 as extension backplanes, the first available I/O module slot on the extension backplane is addressed as the next available slot in the I/O tree, that is, Slot 21.

For your reference, an example backplane is provided followed by the corresponding Studio 5000 and RSLinx I/O tree.

In the example, a 1718-A20 backplane is used with a 1718-AENTR adapter in Slot 0. A mix of single and dual-width I/O modules are shown and leaving empty slots and using 1718-ARM placeholders.

Figure 11 - Example Module Configuration Using a 1718-A20 Backplane

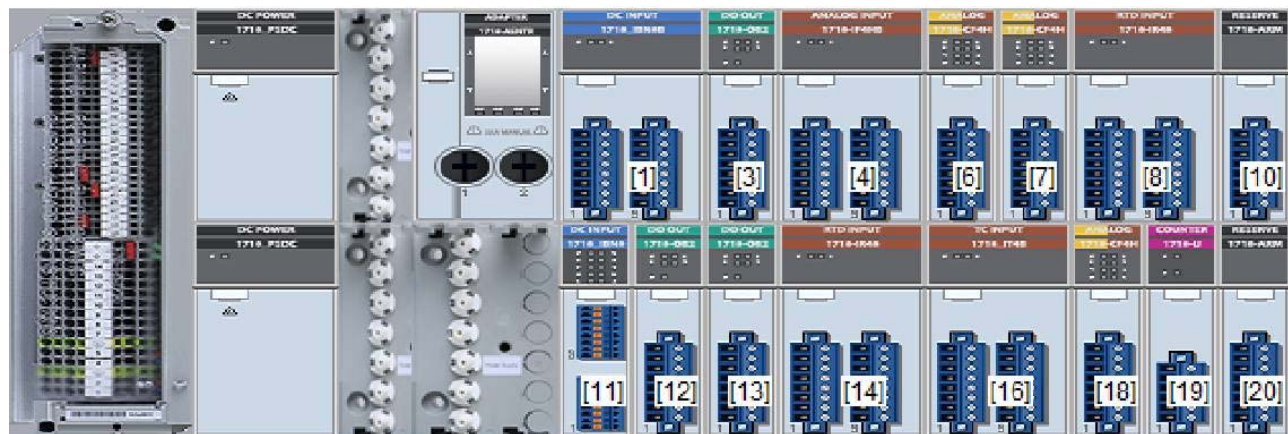

Corresponding Studio 5000® I/O Tree

- 1718-AENTR/A FB20_02_102
 - 1718 Backplane
 - [0] 1718-AENTR/A FB20_02_102
 - [1] 1718-OB2L/A FB20_02_S13
 - [2] 1718-OB2/A FB20_02_S14
 - [3] 1718-IT4B/A FB20_02_S03
 - [5] 1718-IJ/A FB20_02_S05
 - [6] 1718-IF4HB/A FB20_02_S07
 - [8] 1718-CF4H/A FB20_02_S09
 - [9] 1718-IBN8B/A FB20_02_S11
 - [11] 1718-IT4B/A
 - [13] 1718-IBN8B/A
 - [15] 1718-IBN8/A
 - [16] 1718-IBN8/A
 - [17] 1718-IR4B/A
 - [19] 1718-IR4B/A

Corresponding RSLinx® I/O Tree

Address	Device Type
00	1718-AENTR Ex I/O EtherNet/IP Adapter
01	1718-OB2L Ex I/O 2 Point Digital Output 16.5V
02	1718-OB2 Ex I/O 2 Point Digital Output 23V
03	1718-IT4B Ex I/O 4 Channel Thermocouple Input
05	1718-IJ Ex I/O Frequency Counter
06	1718-IF4HB Ex I/O 4 Channel HART Analog Input Wide
08	1718-CF4H Ex I/O 4 Channel HART AnalogConfigurable
09	1718-IBN8B Ex I/O 8 Point Digital Input NAMUR Wide
11	1718-IT4B Ex I/O 4 Channel Thermocouple Input
13	1718-IBN8B Ex I/O 8 Point Digital Input NAMUR Wide
15	1718-IBN8 Ex I/O 8 Point Digital Input NAMUR
16	1718-IBN8 Ex I/O 8 Point Digital Input NAMUR
17	1718-IR4B Ex I/O 4 Channel RTD Input
19	1718-IR4B Ex I/O 4 Channel RTD Input

Notes:

1718 Ex I/O HART Analog I/O Modules

Topic	Page
HART Communication	40
Asset Management Software	41
HART Device Info Tab	42
HART Command Tab - 1718-IF4HB, 1718-CF4H	46
Data in the Input Tags	46
Getting HART Data by Using CIP MSG	52
HART Modules Used with Asset Management Software	52

1718 Ex I/O HART analog I/O modules connect a Logix controller to your process. HART input modules (1718-IF4HB, 1718-CF4H⁽¹⁾) receive signals from process value transmitters and convert them to corresponding measurement values for use in the Logix controller (for example, temperature, flow, pressure, or pH). HART output modules (1718-CF4H⁽¹⁾) provide current or voltage output signals that adjust the settings of valves and other devices in accord with desired process behavior.

Instruments that support the HART protocol allow several process parameters to be measured with one field device, provide status and diagnostics information, and allow remote configuration and troubleshooting.

(1) The 1718-CF4H module can be configured either as an analog input or analog output module.

HART Communication

The HART field communication protocol is widely accepted in industry as a standard for digitally enhanced 4...20 mA communication with smart (microprocessor-based) field devices. A digital signal is superimposed on the 4...20 mA current loop to provide two means of communication from the device. The 4...20 mA analog channel lets the primary process variable be communicated at the fastest possible rate while the digital channel communicates multiple process variables, data quality, and device status. The HART protocol lets these simultaneous communication channels be used in a complementary fashion.

The 1718 Ex I/O HART analog I/O modules support the HART protocol and perform these operations:

- Conversion of 4...20 mA analog signals to digital numeric values in engineering units that are used in the Logix controller.
- Conversion of digital numeric values in engineering units to 4...20 mA analog signals to control process devices.
- Automatic collection of dynamic process data from the connected HART field device (for example, temperature, pressure, flow, or valve position).
- Facilitation of configuration and troubleshooting of the HART field device from your control room using asset management software.

This figure⁽¹⁾ shows information about the HART protocol.

The Highway Addressable Remote Transducer (HART) protocol supports two-way digital communication, complements traditional 4...20 mA analog signals, and includes the following features:

- Predefined commands
 - Common practice
 - General purpose
 - Device specific
- Large installed base
- Worldwide support

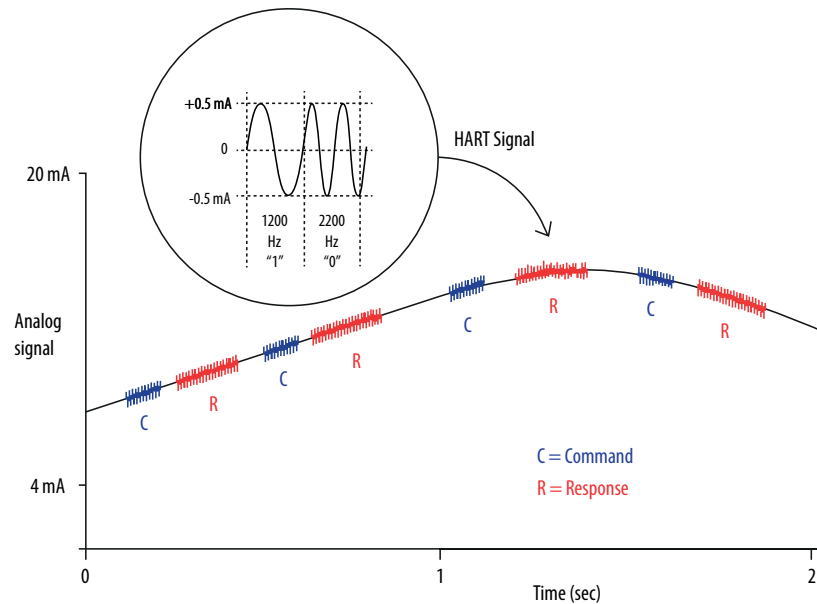

With the 1718 Ex I/O HART analog I/O modules, both the controller and software for device maintenance and management can access field device data.

The 1718 Ex I/O HART analog I/O modules support command-response communication protocol and point-to-point wiring architecture. Multipdrop wiring architecture is not supported.

(1) The figure is from the HART Communication Protocol Specifications, April 2001, Revision 6.0, HART Communication Foundation, All Rights Reserved.

The 1718 EX I/O HART analog I/O modules act as a primary HART master. They support the use of a secondary HART master such as a handheld communicator.

Integrated HART Networks

Most 4...20 mA transmitters are available with a HART protocol interface. The type of data available depends on the type of instrument.

An example application is a HART enabled mass flowmeter. The standard mA signal from the flowmeter provides one primary measurement - flow. The mA signal with HART provides more process information. The mA signal that represents flow is still available. The HART configuration of the flowmeter can be set to communicate primary value (PV), secondary value (SV), third value (TV), and fourth value (FV). These values can represent, for example, mass flow, static pressure, temperature, total flow, etc.

Device status information is also provided via HART. Instead of one process variable, with HART the controller sees four process variables, has a check on the mA signal, and has a reading of device status. HART connectivity provides all this information with no changes to the existing 4...20 mA wiring.

FDT/DTM technology via HART connectivity also provides remote configuration and troubleshooting of field devices by using software such as Endress+Hauser FieldCare software.

HART-enabled I/O Modules

The 1718 Ex I/O HART analog I/O modules have built-in HART modems, so there is no need to install external HART multiplexers or clip-on HART modems. The 1718-IF4HB and 1718-CF4H modules have a separate HART modem for each channel.

Asset Management Software

You can use the HART analog I/O modules with asset management software, such as Endress+Hauser FieldCare software.

HART Device Info Tab

The HART Device Info tab displays information about the attached HART field device that is collected by the HART module.

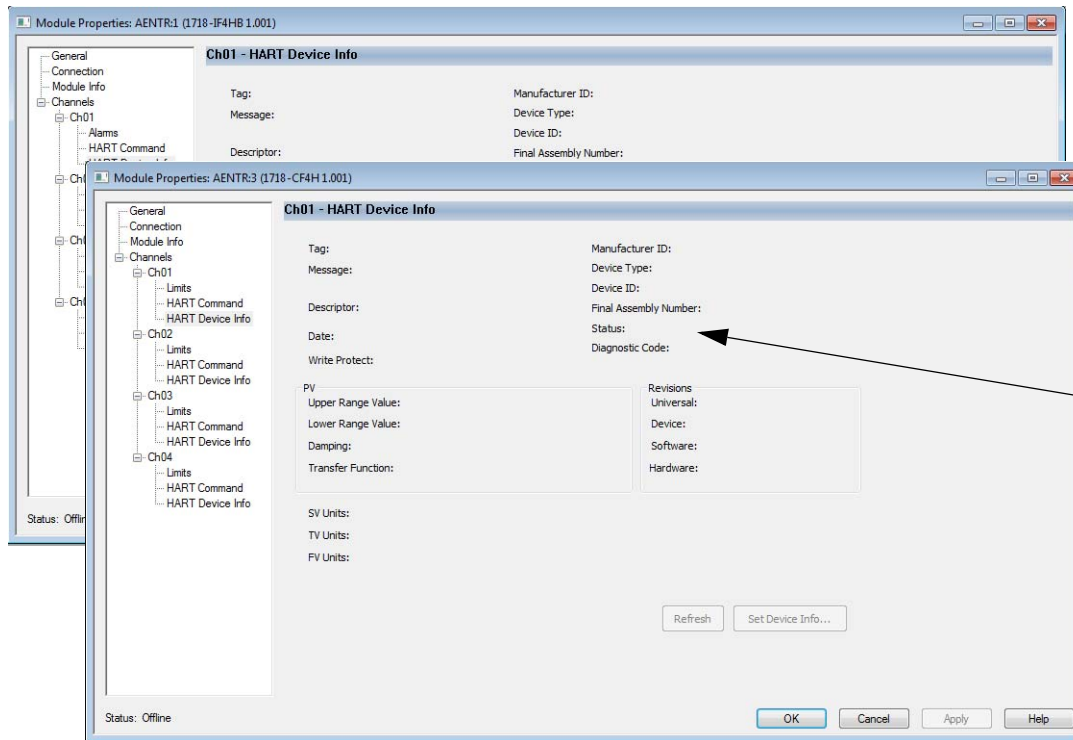

Enhanced diagnostic and status codes are available here depending on your configuration.

- If you selected a Listen-Only communication format when you created the module, this tab is not available.
- If HART is not enabled for this channel, Channel Not HART Enabled is displayed.

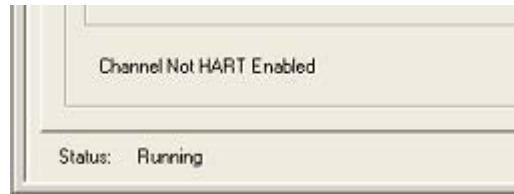

- If HART is enabled, but the HART Field Device is not responding, HART initializing is displayed.

**Table 8 - HART Device Info Tab**

Parameter	Description
Channel	Click a channel to display the parameters for the corresponding channel.
Refresh	Click to update all attributes displayed on this tab for the corresponding channel.
Tag	Displays the tag name of the HART Field Device. The tag name is entered into the Field Device to indicate its location and purpose in the plant.
Message	Displays the text that was entered in the Message parameter of the HART Field Device. The use of this parameter can vary. One possible use is to store information such as who last calibrated the device, or reference to documentation.
Descriptor	Displays the Descriptor field from the HART Field Device. The Descriptor is a text message that can be stored in the device to help identify the device or it can be used for other plant specific purposes.
Date	Displays the date entered in the device. This date is often used to record the last calibration date, but it is up to the end user to maintain it. It is displayed in the format selected for your computer using the Regional and Language settings on the Control Panel.
Write Protect	Displays a Yes or No indicating if the HART Field Device is write protected. If a device is write protected, some parameters cannot be changed via HART communication. Note that sometimes devices do not indicate that the configuration changed when their write-protect setting changes. This causes the previous value to remain displayed here. You can inhibit/uninhibit the HART module to refresh this.
Manufacturer ID	Displays the manufacturer name (for example, Allen-Bradley or Endress + Hauser) or the numeric value for the manufacturer. Use the Company Identification Code table as a guide, as shown in Appendix E.
Device Type	Displays the device type for Endress + Hauser devices or a numeric value for all other manufacturer devices. Device type indicates the manufacturer's type of the device, or product name. For example, Cerabar S pressure transmitters from Endress + Hauser have Device Type 7.
Device ID	Displays a number that represents the device ID. Device ID is a serial number assigned by the manufacturer that is unique among all devices produced by that manufacturer.
Final Assembly Number	Displays a number that represents the final assembly number. The Final Assembly Number is used for identifying the materials and electronics that comprise the field device. It is normally changed when electronics or other components are upgraded in the field. In some instances, this number references a drawing number.

Table 8 - HART Device Info Tab

Parameter	Description
Status	The Field Device status of the selected channel. Status has the following attributes: <ul style="list-style-type: none"> • Device Malfunction • Primary Value (PV) Out of Limits • Loop Current Saturated • Loop Current Fixed • Variable Out of Limits
Diagnostic Code	The diagnostic code information for each channel (up to three error values). If the device is functioning properly, OK is displayed. If the device is not working properly, numeric error values are displayed. To see the additional status in the format sent by the HART field device, send CIP service 16#4C using message instruction.
PV	In HART, the Primary Variable (PV) is signaled on the 4...20 mA analog channel. It can also be read back using HART messages. In many HART devices, the relationship between the PV and the analog signal can be adjusted. This area displays the following Process Variable attributes: <ul style="list-style-type: none"> • Upper Range Value – to use the same engineering units in your Logix controller as in the Field Device, enter this value in High Engineering on the Configuration tab. • Lower Range Value – to use the same engineering units in your Logix controller as in the Field Device, enter this value in Low Engineering on the Configuration tab. • Damping • Transfer Function – describes how the HART field device transforms the signal on its transducer to the PV. Usually Linear, but sometimes Square Root (for example, for flow), or other relationships.
Revision	Displays the following revision attributes. <ul style="list-style-type: none"> • Universal - this denotes the version of the HART specification to which the device conforms. • Device • Software • Hardware

Set Device Info (1718-IF4HB, 1718-CF4H)

For the 1718-IF4HB and 1718-CF4H modules with Configure HART Device set to Yes, a Set Device Info button appears on the HART Device Info tab. The Set Device Info button is enabled when the controller is on line and not in hard run mode. Clicking this button displays a dialog box that lets you specify tag name, message and descriptor for the HART device on the selected channel. You can enter values in the text fields or copy existing entries already stored on the device. When you click the Set button, the specified values are sent to the device via HART messages.

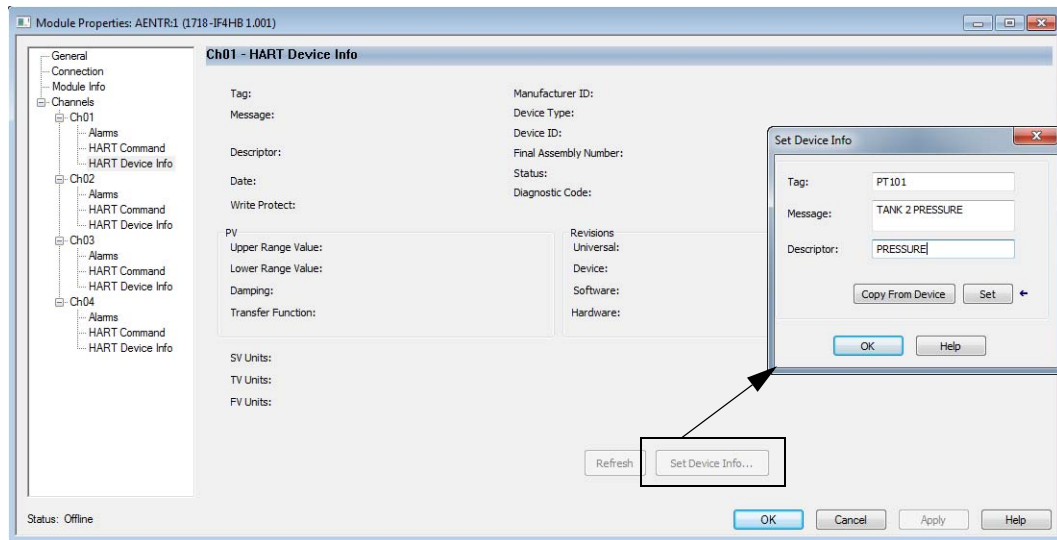

HART Command Tab - 1718-IF4HB, 1718-CF4H

When Configure HART Device is set to Yes for the 1718-IF4HB and 1718-CF4H modules, a HART Command tab appears in the Module Properties dialog.

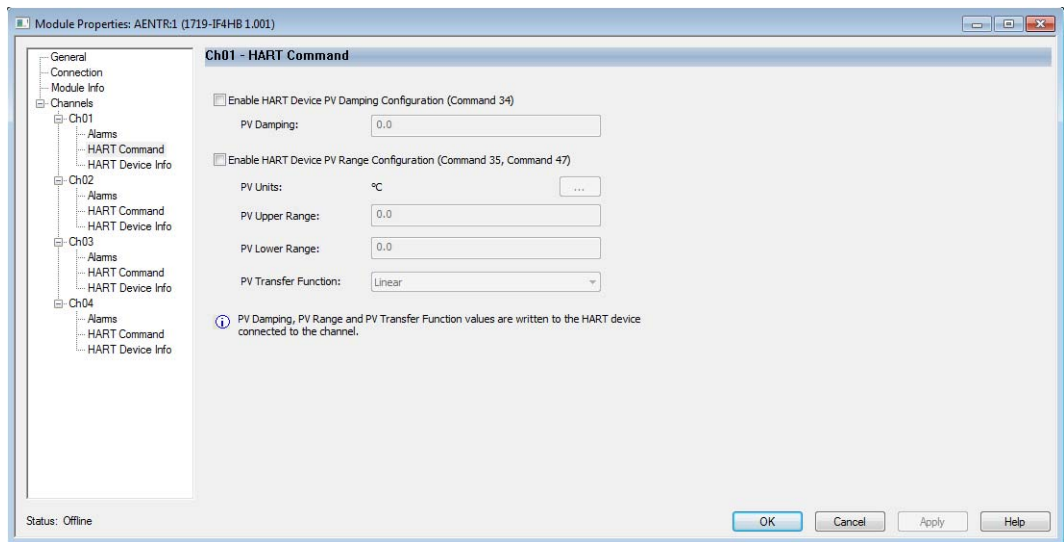

In the HART Command tab, you can specify HART device parameters for each channel. These values are sent to the HART device

Checkbox	Parameter	Description
Enable HART Device PV Damping Configuration	PV Damping	
Enable HART Device PV Range Configuration	PV Units	Engineering units for the HART PV. Choose from the dropdown list. See Appendix D on page 71 for a list of unit codes.
	PV Upper Range	Highest value for PV in the specified engineering units.
	PV Lower Range	Lowest value for PV in the specified engineering units.
	PV Transfer Function	Form of the PV transfer function. Choose from the dropdown list.

Data in the Input Tags

When HART data is included in the input tag and a channel has HART enabled, the 1718 Ex I/O HART I/O module automatically collects HART data and places the most common Dynamic Process Data and Device Health information directly in the input tag.

An overview of the HART data includes the following:

- HART Faults – At the beginning of the input tag included even if you click Analog Only input data tag format. These faults indicate that HART communication is not successful or that the field device is reporting a problem such as Device Malfunction, Loop Current Saturated or PV out of Limit. For example, Ch0HARTFault is set if Ch0Config.HARTEn is 0 or if no HART Field Device is attached.

- HART Device Status – A collection of status indicators that reflect the HART communication details and overall device health.
 - Init – Module is searching for a HART device.
 - Fault – HART communication is not successful. If this is 1 and Initializing is 0, probable cause is HART is not enabled on this channel.
 - Message Ready – A HART pass-through message reply is ready to be collected by using the Pass-through Query CIP message. For information on using CIP MSGs to access HART data, refer to the ControlLogix HART Analog I/O Modules User manual, publication [1756-UM333](#).
 - Current Fault – The analog current doesn't match the readback of the current received over the HART communication. This might be caused by an inaccurate field device, faulty wiring, or water in the conduit. Sometimes a rapid change in the signal results in a transient current fault as the analog and digital representations are sampled at slightly different times and at different places in the signal path.
 - Configuration Changed – The Field Device configuration has changed and new Field Device configuration information can be obtained from the module via CIP MSG GetDeviceInfo, which will clear this bit.
 - ResponseCode – HART Communication Status or Response Code. 0 means success.
 - FieldDeviceStatus – HART device health, such as PV out of range or device malfunction. See [Appendix C on page 59](#) for details.
 - UpdatedStatusReady – indicates new device diagnostic information is available, which can be obtained by sending a CIP Message with Service 4C.

HART Dynamic Variables

Most HART devices are capable of measuring several different process characteristics or of deriving other measurements from directly sensed measurements. For example, many differential pressure transmitters can also sense the process temperature and can calculate the flow, or they might calculate the volume in a tank based on a measurement of its head pressure and knowledge of tank geometry and product density.

The most important of these direct or derived measurements is assigned to the PV (Primary Variable) and the analog signal will represent its value. Additional measurements can be read from the HART field device over the HART communication protocol. HART provides a standard message for reading four of the dynamic variables, called PV, SV, TV, and FV (sometimes called QV). These four dynamic variables are the four measurements of interest to a controller.

These four dynamic variables - PV, SV, TV, and FV - are automatically collected from the HART field device and placed in the module's input tag in HART.ChxPV (for Analog and HART PV data format) or Chxx.PV (for Analog and HART by Channel data format). In some HART devices, the choice of which of the available measurements to assign to PV, SV, TV, and FV can be

changed via configuration. In other more simple devices, the assignment is done at the factory and cannot be changed.

An example for a Flow Meter might be:

- PV - Primary Variable. Flow Rate in Liters per Minute.
- SV - Secondary Variable. Process Temperature in °C.
- TV - Third or Tertiary Variable. Product Density in Grams per Cubic Centimeter.
- FV - Fourth or Quaternary Variable

An example for a Valve Positioner might be:

- PV - Primary Variable. Commanded position in %.
- SV - Secondary Variable. Actual position in %.
- TV - Third or Tertiary Variable. Air Pressure in PSI.
- FV - Fourth or Quaternary Variable. Loop current in mA.

In addition to the measurement value, HART devices can provide status information that indicates the quality of the measurement.

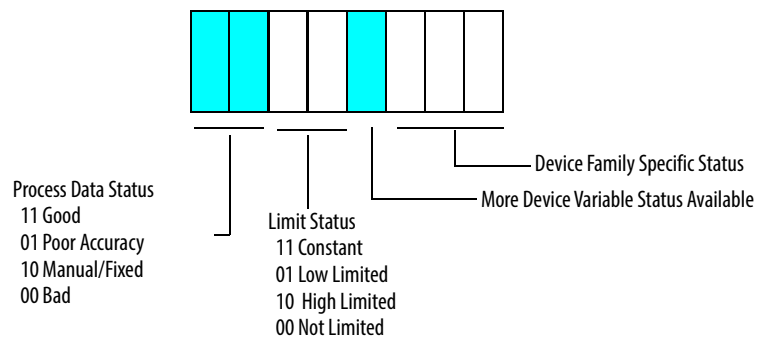

For example, if a valve positioner cannot open any further, it should set its HART.ChxSVStatus to 2#11100000 to indicate that the actual position value in the SV is Good (accurately measured) but is the subject of a High Limit. This status information can be used for windup control in PID loops and for other diagnostic purposes.

The module collects the PV, SV, TV, and FV data as described in [Table 9](#).

Table 9 - Dynamic Variable Assignment

HART Version	HART Device Reports PV, SV, TV, FV Assignments in Command 50	HART Command Used by 1718 Module to Collect PV, SV, TV, FV	Device Variable Codes Used in Command 9 for PV, SV, TV, FV
5	N/A	3	N/A
6	No	3	N/A
	Yes	9	As Reported in Command 50
7 or later	No	9	246, 247, 248, 249
	Yes		As Reported in Command 50

Command 3 does not provide PVStatus, SVStatus, TVStatus, or FVStatus, so HART devices that indicate Command 3 as shown in [Table 9](#) will have their Dynamic Variable Status values reported based on the communication status with the HART field device. If the Dynamic Variables are being collected without communication error, the Status value is 16#C0 (2#11000000), which means good. Otherwise, it is 0, meaning bad.

Some devices don't have four dynamic variables. In this case, they can report a NaN value to indicate they have no valid value for that parameter.

The dynamic variables do not update as fast as the analog signal. The actual rate depends on the number of channels configured for HART, the number of pass-through message commands, the presence of handheld communicators or other secondary masters, and the response speed of the field device.

IMPORTANT Verify that the actual HART update rate is appropriate for your application. Remember that pass-through message traffic, additional status information, secondary masters, and communication errors can delay the update rate.

IMPORTANT Verify that HART data is valid by checking ChxFault, HARTFault, and values such as PVStatus and SVStatus.

How the Module Automatically Collects Data

The 1718 Ex I/O HART analog module automatically sends HART messages to characterize the HART field device and collect the dynamic variables. It also collects additional status information when the device indicates it is available. When the device indicates its configuration has changed, HART messages are sent to reread the configuration information so that a current copy is cached in the modules.

[Figure 12 on page 51](#) shows the general flow of the start-up characterization, response to a new configuration, and cyclic scanning of dynamic variables. Not shown are periodic checks of the current and reading the additional status information.

In addition to the HART activities outlined in the diagram, if there are HART pass-through messages to send, they are interleaved in the auto scanning. Logix controllers can send pass-through messages using CIP MSG instructions, and Asset Management systems can send them. For more information, refer to the ControlLogix HART Analog I/O Modules User manual, publication [1756-UM333](#).

If the HART field device configuration is changed—from a handheld, asset management, or device faceplate—cyclic reading of the Dynamic Variables pauses briefly while the configuration changes are assimilated. The HART.ChxDeviceStatus.ConfigurationChanged status is set when the updated configuration is retrieved from the HART field device and stored in the module to indicate that new data is available for GetDeviceInfo CIP MSG.

For more information, refer to the ControlLogix HART Analog I/O Modules User manual, publication [1756-UM333](#).

Figure 12 - 1718-IF4HB and 1718-CF4H Flow Chart

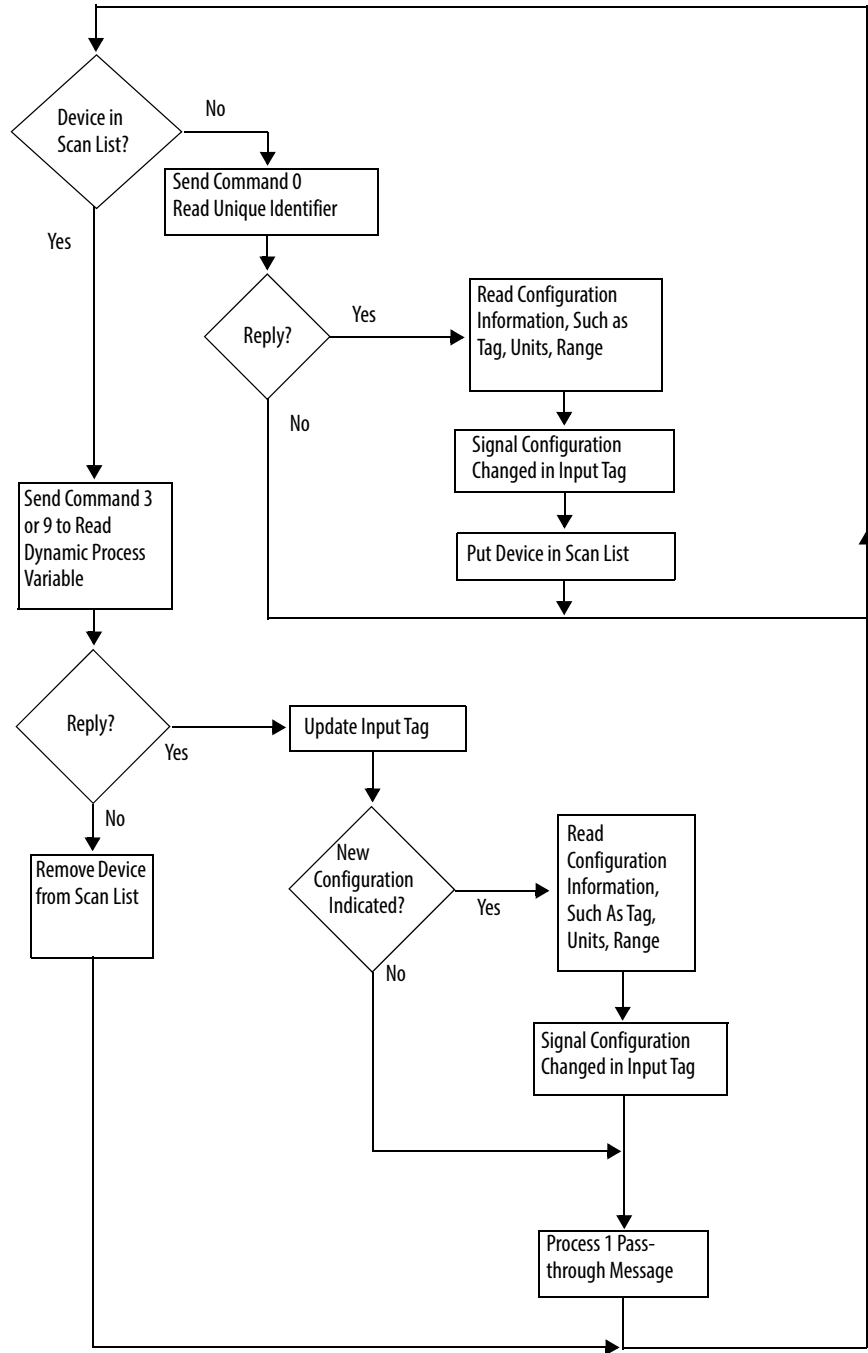

Getting HART Data by Using CIP MSG

For information about how to use HART data in your Logix controller via MSG instructions, refer to the ControlLogix HART Analog I/O Modules User manual, publication [1756-UM333](#).

HART Modules Used with Asset Management Software

Considerations for Asset Management Systems

The following must be considered before using the I/O modules with asset management systems, such as Endress+Hauser FieldCare systems.

- HART must be enabled before any asset management system access is possible, including scanning for multiplexers, if supported by your asset management software. You do not need to include HART PV or HART by Channel data in your input tag, but you do need to check the Enable HART box on the Configuration tab of the Module Properties dialog box.
- The Logix controller must be connected to the I/O module. If the Logix controller is not connected, the module configuration was not sent to the HART module, and the channel is not yet configured for HART access.
- If you use a handheld HART communicator and configuration tool, such as Rosemount 275 or Meriam, configure the tool as the secondary master. The Meriam handheld has a high-speed mode, which assumes it is the only master present. In this mode, the handheld may conflict with the I/O module. Usually, the Meriam handheld automatically detects the proper setting, but if not, set it manually.
- The ConfigurationChanged indication in the Field Device Status is automatically reset by the I/O module. Asset management systems might miss this indication if they are offline at the time of a change.
- A separate configuration-changed indication is in the field device status for the primary master (1718-IF4HB or 1718-CF4H) and secondary master (handheld, for example). The I/O modules do not reset the secondary master configuration changed status.

HART traffic from asset management pass-through messages or from secondary masters slows the update rate of HART data in the controller or other pass-through message clients. In the 1718-IF4HB or 1718-CF4H modules, extra traffic on one channel also affects other channels.

Frequently Asked Questions

Read this section for answers to frequently asked questions.

How do you use 1718 Ex I/O HART analog I/O modules as part of an asset management system?

HART I/O modules let most asset management software packages communicate through the modules to HART field devices. Use RSLinx software to let the asset management software communicate through the NetLinx networks and 1718 backplane.

What else is required to use asset management software with a 1718 Ex I/O HART analog I/O module?

For Field Device Tool (FDT)/Device Type Manager (DTM) based asset management software such as E+H FieldCare, you use communication DTMs from Rockwell Automation.

What is FDT/DTM?

FDT/DTM is a technology for managing intelligent devices.

E+H FieldCare asset management software is an FDT frame application. The frame application runs the DTM files. The DTM files are executable files that are provided by control and device vendors. There are communication DTMs and device DTMs.

We provide communication DTMs for components in the integrated architecture. Companies such as Endress+Hauser and Metso provide device DTMs for their instruments and valves. The device DTMs provide visualization of the parameters that are needed to configure, monitor, and maintain the devices.

See <http://www.fdtgroup.org> for more information on FDT/DTM technology and to search for registered DTMs.

What communication DTM is used with the 1718 Ex I/O HART analog I/O modules?

Go to the Rockwell Automation Product Compatibility and Download Center (<http://www.rockwellautomation.com/rockwellautomation/support/pcdc.page>), click the Download link, and search for FactoryTalk® Linx CommDTM to obtain the DTM.

What if a DTM is not available for my HART field device?

A generic DTM is available (included with FieldCare) that provides basic access to devices.

Notes:

Troubleshooting

Topic	Page
Communication Errors	55
Signal Faults	56



WARNING: Risk of explosion

When work is performed on the distributed I/O station in hazardous areas, there is a risk of explosion from spark formation.

Before embarking on any work on the distributed I/O station, familiarize yourself with the operating instructions for the components and their certificates of compliance, and read the 1718 Ex I/O User Manual.

Communication Errors

See the following table for the recommended actions when troubleshooting communication errors.

Recommended Action for Communication Errors

Error	Remedy
Communication error on EtherNet/IP	<ul style="list-style-type: none"> • Check that the cables are connected. • Check that the transmitting and receiving lines are wired correctly and have not been swapped. • Check that the nodes are positioned in linear, star, or ring form and without branches. • In the configuration software, check that the selected address is the same as the distributed I/O station address.
The software cannot locate an adapter when establishing the connection	Check that the adapter is plugged in correctly.

Signal Faults

See the following table for the recommended actions when troubleshooting signal faults.

Recommended Action for Signal Faults

Error	Remedy
Faulty signal	<ul style="list-style-type: none"> • Check if there is a short circuit or lead breakage within the circuit. • Check that the field devices and sensors are working properly. • Check the communication path to the I/O module. • If necessary, replace the I/O module.
All signals for a module are faulty	<ul style="list-style-type: none"> • Check that the power supply is working properly. • Check the bus connection.
The output module switches off	<ul style="list-style-type: none"> • Communication with the adapter is interrupted. • Check that the I/O module is plugged into the backplane properly.
Input module sporadically delivers no measured values	<ul style="list-style-type: none"> • Communication with the adapter is interrupted. • Check that the I/O module is plugged into the backplane properly.
Measured values occasionally incorrect	<ul style="list-style-type: none"> • Check whether the measured value is being distorted by external influences. • Check that the shielding is intact.
I/O module reported to be faulty	<ul style="list-style-type: none"> • Check that the correct I/O module is plugged in. • Check that the green LED on the I/O module is lit and that the I/O module is correctly plugged in.

Technical Data

Topic	Page
Power Supply	57
Mechanical Data	57
Ambient Conditions	58



ATTENTION: Damage to equipment

Equipment can be damaged by voltages that are too high, for example, in temporary faulty operation.

Power Supply

Rated voltage: 24V DC

Use a suitable power supply to implement another supply voltage of 24V DC. The maximum permitted supply voltage for an upstream power supply is 253V AC.

Power consumption:

- ≤ 44 W
- parallel connection with other 1718-PSDC (automatic power sharing)

Mechanical Data

Weight:

- Backplane 1718-A10: 2735 g (96.47 oz)
- Backplane 1718-A20: 2725 g (96.12 oz)

Dimensions:

- Backplanes: See [Design and Dimensions on page 11](#)
- Single-width I/O modules: 16 x 100 x 103 mm (0.63 x 3.94 x 4.06 in.)
- Dual-width I/O modules: 32 x 100 x 103 mm (1.26 x 3.94 x 4.06 in.)
- Adapters and power supplies: 57 x 107 x 132 mm (2.2 x 4.2 x 5.2 in.)

Ambient Conditions

Ambient temperature:

- Power supplies, I/O modules with non-intrinsically safe circuits:
-20...+60 °C (-4 ...+140 °F)
- Adapters, I/O modules with intrinsically safe circuits:
-20...+60 °C (-4 ...+140 °F)

Storage temperature: -25...+85 °C (-13 °F ... +185 °F)

Relative humidity: 95% noncondensing

Designed for pollution degree 2

Additional HART Protocol Information

This appendix discusses these topics.

Topic	Page
Message Structure	60
Response Code and Field Device Status	61
HART PV, SV, TV, and FV Status	67

This appendix describes the HART protocol and provides references for additional information about the protocol. Consult the HART protocol specification and vendor-provided documentation for specifics on HART commands.

This appendix provides the following:

- HART protocol background information
- Common practice command sets
- Extended command sets
- References to additional information

HART Field Communication Protocol is widely accepted in the industry as the standard for digitally enhanced 4...20 mA communication with smart field instruments. The HART Protocol message structure, command set, and status are discussed in this appendix.

The HART command set is organized into these groups and provides read and write access to a wide array of information available in smart field instruments:

- Universal commands provide access to information that is useful in normal plant operation such as the instrument manufacturer, model, tag, serial number, descriptor, range limits, and process variables. All HART devices must implement universal commands.
- Common practice commands provide access to functions that can be carried out by many devices.
- Device specific commands provide access to functions that can be unique to a particular device.

Message Structure

Read this section for a description of transaction procedure, character coding, and message structure of the HART protocol. These correspond to layer 2 (data-link layer) of the OSI protocol reference model.

Master-slave Operation

HART is a master-slave protocol. This means that each message transaction is originated by the master; the slave (field) device replies when it receives a command message addressed to it. The reply from the slave device acknowledges that the command was received and can contain data requested by the master.

Multiple Master Operation

The HART protocol provides for two active masters in a system: one primary and one secondary. The two masters have different addresses. Each can positively identify replies to its own command messages. The 1718-IF4HB or 1718-CF4H module acts as primary master. A secondary master, such as a handheld configuration device, may also be connected.

Transaction Procedure

HART is a half-duplex protocol. After completion of each message, the FSK carrier signal must be switched off to let the other station transmit. The carrier control timing rules state that the carrier should be turned on not more than 5 bit times before the start of the message (that is, the preamble) and turned off not more than 5 bit times after the end of the last byte of the message (the checksum).

The master is responsible for controlling message transactions. If there is no reply to a command within the expected time, the master should retry the message. After a few retries, the master should abort the transaction, because presumably the slave device or the communication link has failed.

After each transaction is completed, the master should pause for a short time before sending another command, to provide an opportunity for the other master to break in if it wishes. This way, two masters (if they are present) take turns at communicating with the slave devices. Typical message lengths and delays allow two transactions per second.

Burst Mode

Burst mode is not supported by the 1718 HART analog modules.

Response Code and Field Device Status

Two bytes of status also called the response code and field device status are included in every reply message from a field or slave device. These two bytes convey communication errors, command response problems, and field device status. If an error is detected in the outgoing communication, the most significant bit (bit 7) of the first byte is set to 1 and the details of the error are reported in the rest of that byte. The second byte is then all zeros.

Communication errors are typically those that would be detected by a UART (parity overrun and framing errors). The field device also reports overflow of its receive buffer and any discrepancy between the message content and the checksum received.

In the Studio 5000 software application, if the leftmost bit of the ResponseCode is set, it displays a negative number. In this case, the ResponseCode represents a communication fault. Change the display format to hexadecimal to interpret communication status.

If the leftmost bit of the ResponseCode is 0 (value 0..127), then there was no communication error and the value is a ResponseCode from the HART field device. Response codes indicate if the device performed the command. 0 means no error. Other values are errors or warnings. To understand the ResponseCode, contact your HART field device manufacturer or the HART specification.

See [Table 1](#) for descriptions of the response code and the field device status.

Table 1 - Response Codes and Field Device Status

Response Code		Description	
If Bit 7 is	And Bits 6...0 are		
1	16#40	Parity Error	Vertical parity error - The parity of one or more of the bytes received by the device was not odd
1	16#20	Overrun Error	Overrun error - At least one byte of data in the receive buffer of the UART was overwritten before it was read (for example, the slave did not process incoming byte fast enough)
1	16#10	Framing Error	Framing error - The Stop Bit of one or more bytes received by the device was not detected by the UART (for example, a mark or 1 was not detected when a Stop Bit should have occurred)
1	16#08	Checksum Error	Longitudinal parity error - The Longitudinal Parity calculated by the device did not match the Check Byte at the end of the message
1	16#04	(Reserved)	Reserved - Set to zero
1	16#02	RX Buffer Overflow	Buffer overflow - The message was too long for the receive buffer of the define
1	16#01	(undefined)	Reserved - Set to zero
0	0	No command specific error	
0	1	(undefined)	
0	3	Value too large	
0	4	Value too small	
0	5	Not enough bytes in command	
0	6	Transmitter-specific command error	
0	7	In Write-protect mode	
0	8	Update Failed - Update In Progress - Set to Nearest Possible Value	
0	9	Applied Process Too High - Lower Range Value Too High - Not In Fixed Current Mode	

Table 1 - Response Codes and Field Device Status (Continued)

Response Code		Description
If Bit 7 is	And Bits 6...0 are	
0	10	Applied Process Too Low - Lower Range Value Too Low - MultiDrop Not Supported
0	11	In MultiDrop Mode - Invalid Transmitter Variable Code - Upper Range Value Too High
0	12	Invalid Unit Code - Upper Range Value Too Low
0	13	Both Range Values Out of Limits
0	14	Pushed Upper Range Value Over Limit - Span Too Small
0	16	Access restricted
0	32	Device busy
0	64	Command not implemented

If no error was detected in the outgoing communication, the second byte contains status information pertaining to the operational state of the field or slave device.

Table 2 - Field Device Status Bit Mask Definitions

Bit	Bit Mask	Definition
7	16#80	Device malfunction - The device detected a serious error or failure that compromises device operation
6	16#40	Configuration changed - An operation was performed that changed the device's configuration
5	16#20	Cold start - A power failure or device reset occurred
4	16#10	More status available - More status information is available through command 48, Read Additional Status Information
3	16#08	Loop current fixed - The loop current is being held at a fixed value and is not responding to process variations
2	16#04	Loop current saturated - The loop current has reached its upper or lower endpoint limit and cannot increase or decrease any further
1	16#02	Non-primary variable out of limits - A device variable not mapped to the PV is beyond its operating limits
0	16#01	Primary variable out of limits - The PV is beyond its operating limit

IMPORTANT The 16# means this number is Hex display style.

Table 3 - HART Universal Commands

Command		Data in Command			Data in Reply			Contained in	
No.	Function	Byte	Data	Type ⁽¹⁾	Byte	Data	Type ⁽¹⁾	Input Tag	CIP MSG
0	Read Unique Identified		None		0	254 (expansion)	(H) (B)		X
					1	Manufacturer identification code			
					2	Manufacturer device type code			
					3	Number of preambles required			
					4	Universal command revision			
					5	Device-specific command revision			
					6	Software revision			
					7	Hardware revision			
					8	Device function flags ⁽²⁾			
					9...11	Device ID number			
1	Read primary variable				0	PV units code	(F)	x	X
					1...4	Primary variable			
2	Read current and percent of range		None		0...3	Current (mA)	(F)	x	X
					4...7	Primary variable %			

Table 3 - HART Universal Commands

Command		Data in Command			Data in Reply			Contained in		
No.	Function	Byte	Data	Type ⁽¹⁾	Byte	Data	Type ⁽¹⁾	Input Tag	CIP MSG	
3	Read current and four (predefined) dynamic variables		None		0...3 4 5...8 9 10...13 14 15...18 19 20...23	Current (mA) PV units code Primary variable SV units code Secondary variable TV units code Third variable FV units code Fourth variable ⁽³⁾			X X X X X X X X	
6	Write polling address	0	Polling address			As in command				
11	Read unique identifier associated with tag	0...5	Tag	(A)	0...11					
12	Read message		None		0...23	Message (32 characters)	(A)		X	
13	Read tag, descriptor, date					0...5 6...17 18...20	Tag (8 characters) Descriptor (16 characters) Date	(A) (A) (D)		X X X
14	Read PV sensor information					0...2 3 4...7 8...11 12...15	Sensor serial number Units code for sensor limits and min span Upper sensor limit Lower sensor limit Min span	(B) (F) (F) (F)		
15	Read output information					0 1 2 3...6 7...10 11...14 15 16	Alarm select code Transfer function code PV/range units code Upper range value Lower range value Damping value (seconds) Write-protect code Private-label distributor code	(F) (F) (F)		X X X X X X
16	Read final assembly number					0...2	Final assembly number	(B)		X
17	Write message	0...23	Message (32 characters)	(A)		As in command				
18	Write tag, descriptor, date	0...5 6...17 18...20	Tag (8 characters) Descriptor (16 characters) Date	(A) (A) (D)						
19	Write final assembly number	0...2	Final assembly number	(B)						
48	Read additional device status		Starting in HART version 7, the data in the command could be the same as in the reply.		0...5 6...7 8 9 10 11 12 13 14...24	Device-specific status Operational modes Standardized status 0 Standardized status 1 Analog channel saturated Standardized status 2 Standardized status 3 Analog channel fixed ⁽⁴⁾ Device-specific status	s ⁽⁵⁾		X X X X X X X X X	

(1) (A) = Packed ASCII, (B) = 3-byte integer, (D) = Date, (F) = Floating Point (HART format), (H) = HART flag
 (2) Bit 6 = multisensor device. Bit 1 = EEPROM control required. Bit 2 = protocol bridge device.
 (3) Truncated after last supported variable.
 (4) 24 bits each LSB...MSB refers to A0 #1...24.
 (5) Sint []

Table 4 - Common Practice Commands

Command		Data in Command			Data in Reply			Contained in		
No.	Function	Byte	Data	Type ⁽⁶⁾	Byte	Data	Type ⁽⁶⁾	Input Tag	CIP MSG	
33	Read transmitter variables		None		0 1 2...5 6 7 8...11 12 13 14...17 18 19 20...23	Transmitter variable code for slot 0 Units code for slot 0 Variable for slot 0 Transmitter variable code for slot 1 Units code for slot 1 Variable for slot 1 Transmitter variable code for slot 2 Units code for slot 2 Variable for slot 2 Transmitter variable code for slot 3 Units code for slot 3 Variable for slot 3 ⁽⁷⁾	(F) (F) (F)			
34	Write damping value	0...3	Damping value (seconds)	(F)		As in command	(F)			
35	Write range values	0 1...4 5...8	Range units code Upper-range value Lower-range value	(F) (F)			(F) (F)			
36	Set upper-range value (= push SPAN button)		None			None				
37	Set lower-range value (= push ZERO button)									
38	Reset 'configuration changed' flag									
39	EEPROM control	0		EEPROM control code ⁽³⁾				As in command		
40	Enter/exit Fixed Current mode	0...3 (1)	Current (mA)	(F)		As in command				
41	Perform device self-test		None			None				
42	Perform master reset									
43	Set (trim) PV zero									
44	Write PV units	0	PV units code			As in command				
45	Trim DAC zero	0...3	Measured current (mA)							
46	Trim DAC gain	0...3		(F)						
47	Write transfer function	0	Transfer function code							
48	Read additional device status		Moved to Universal Commands in HART version 7.			See 48 in Universal Commands				
49	Write PV sensor serial number	0...2	Sensor serial number			As in command				
50	Read dynamic variable assignments		None	0 1 2 3		PV transmitter variable code SV transmitter variable code TV transmitter variable code FV transmitter variable code			x x x x	

Table 4 - Common Practice Commands

Command		Data in Command			Data in Reply			Contained in	
No.	Function	Byte	Data	Type ⁽⁶⁾	Byte	Data	Type ⁽⁶⁾	Input Tag	CIP MSG
51	Write dynamic variable assignments	0 1 2 3	PV transmitter variable code SV transmitter variable code TV transmitter variable code FV transmitter variable code			As in command			
52	Set transmitter variable zero	0	Transmitter variable code						
53	Write transmitter variable units		Transmitter variable code						
54	Read transmitter variable information		Transmitter variable code		0 1...3 4 5...8 9...12 13...16	Transmitter variable code Transmitter variable sensor serial Transmitter variable limits units code Transmitter variable upper limit Transmitter variable lower limit Transmitter variable damping value (seconds)	(F) (F) (F)		
55	Write transmitter variable damping value	0 1...4	Transmitter variable code Transmitter variable damping value (seconds)			As in command			
56	Write transmitter variable sensor serial number	0 1...3	Transmitter variable code Transmitter variable sensor			As in command			
57	Read unit tag, description, date		None		0...5 6...17 18...20		(A) (A) (D)		x x x x
58	Write unit tag, descriptor, date	0...5 6...17 18...20 0	Unit tag (8 characters) Unit descriptor (16 characters) Unit date	(A) (A) (D)					
59	Write number of response preambles	0	Number of response preambles						
60	Read analog output and percent of range	0	Analog output number code		0 1 2...5 6...9	Analog output number code Analog output units code Analog output level Analog output percent of range			
61	Read dynamic variables and PV analog output		None		0 1...4 5 6...9 10 11...14 15 16...19 20 21...24	PV analog output units code PV analog output level PV units code Primary variable SV units code Secondary variable TV units Tertiary variable FV units code Fourth variable	(F) (F) (F) (F) (F) (F)	x x x x x x	x x x x x x

Table 4 - Common Practice Commands

Command		Data in Command			Data in Reply			Contained in							
No.	Function	Byte	Data	Type ⁽⁶⁾	Byte	Data	Type ⁽⁶⁾	Input Tag	CIP MSG						
62	Read analog outputs	0	Analog output number; code for slot 0	0		Slot 0 analog output number code	(F)								
		1	Analog output number; code for slot 1	1		Slot 0 level									
		2	Analog output number; code for slot 2	2...5		Slot 1									
		3 ⁽²⁾	Analog output number; code for slot 3 ⁽⁴⁾	6		Slot 1 level									
63	Read analog output information	0	Analog output number code	7		Slot 2	(F)								
		1	Analog output number code	8...11		Slot 2 level									
		2	Analog output number code	12		Slot 3									
		3	Analog output number code	13		Slot 3 level ⁽⁸⁾									
64	Write analog output additional damping value	0	Analog output number code	14...17	(F)	Slot 2 level	(F)								
		1...4	Analog output additional damping value (seconds)	18		Slot 3									
		65	Write analog output range value	0		Analog output number code				19	(F)	Slot 3 level	(F)		
				1		Analog output range units code				20...23		Slot 3 level ⁽⁸⁾			
66	Enter/exit Fixed Analog Output mode	0	Analog output number code	0	(F)	Analog output number code	(F)								
		1	Analog output units code	1		Analog output alarm select code									
		2...6	Analog output level ⁽⁵⁾	2		Analog output transfer function code									
67	Trim analog output zero	0	Analog output number code	3	(F)	Analog output range units code	(F)								
		1	Analog output units code	4...7		Analog output upper-range value									
		2...6	Externally measured analog output level	8...11		Analog output lower-range value									
68	Trim analog output gain	0	Analog output number code	12...15	(F)	Analog output additional damping value (seconds)	(F)								
		1	Analog output units code	As in command		(F)									
		2...6	Externally measured analog output level												
69	Write analog output transfer function	0	Analog output number code												
		1	Analog output transfer function code												
70	Read analog output endpoint values	0	Analog output number code			Analog output number code									

Table 4 - Common Practice Commands

Command		Data in Command			Data in Reply			Contained in	
No.	Function	Byte	Data	Type ⁽⁶⁾	Byte	Data	Type ⁽⁶⁾	Input Tag	CIP MSG
107	Write Burst mode transmitter variables (for command 33)	0 1 2 3	Transmitter variable code for slot 0 Transmitter variable code for slot 1 Transmitter variable code for slot 2 Transmitter variable code for slot 3			As in command			
108	Write Burst mode command number	0	Burst mode command number			As in command			
109	Burst mode control	0	Burst mode control code (0 = exit, 1 = enter)						
110	Read all dynamic variables		None		0 1...4 5 6...9 10 11...14 15 16...19	PV units code PV value SV units code SV value TV units code TV value FV units code FV value	(F) (F) (F) (F)	x x x x x x x x	x x x x x x x x

- (1) 0 = exit Fixed Current mode.
(2) Truncated after last requested code.
(3) 0 = burn EEPROM, 1 = copy EEPROM to RAM.
(4) Truncated after last requested code.
(5) Not a number exits Fixed-output mode.
(6) (A) = Packed ASCII, (B) = 3-byte integer, (D) = Date, (F) = Floating Point (HART format), (H) = HART flag
(7) Truncated after last requested code. Truncated after last requested variable.
(8) Truncated after last requested level.

HART PV, SV, TV, and FV Status

HART PV, SV, TV, and FV are dynamic variables that contain the values of device variables, which are various direct or indirect process measurements performed by the HART field device.

Some devices let a set of their internal device variables be mapped to the PV, SV, TV, FV dynamic variables that are automatically collected in the 1718-IF4HB and 1718-CF4H Input Tag.

This mapping is part of the field device configuration, usually performed using a handheld configurator or asset management system, such as Endress+Hauser FieldCare system.

HART PVStatus, SVStatus, TVStatus, FVStatus are known as Device Variable Status values. These Status values are composed of groups of bits that indicate the quality of the associated device variable.

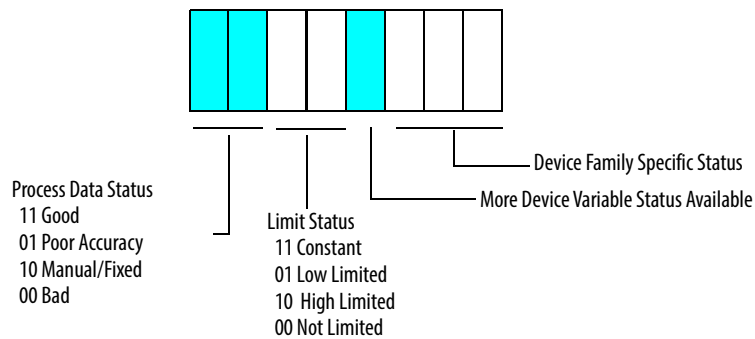

The Limit Status can be used to control windup in PID loops.

Table 5 - HART PV, SV, TV, and FV Status Values

HART PV, SV, TV FV Status Values			Quality		Limit		More Status Available?		Device Family Specific	
Decimal	Hex	Binary							Binary	Decimal
0	0	00000000	00	Bad	00	Not Limited	0	No	000	0
1	1	00000001	00	Bad	00	Not Limited	0	No	001	1
2	2	00000010	00	Bad	00	Not Limited	0	No	010	2
3	3	00000011	00	Bad	00	Not Limited	0	No	011	3
4	4	00000100	00	Bad	00	Not Limited	0	No	100	4
5	5	00000101	00	Bad	00	Not Limited	0	No	101	5
6	6	00000110	00	Bad	00	Not Limited	0	No	110	6
7	7	00000111	00	Bad	00	Not Limited	0	No	111	7
8	8	00001000	00	Bad	00	Not Limited	1	Yes	000	0
9	9	00001001	00	Bad	00	Not Limited	1	Yes	001	1
10	A	00001010	00	Bad	00	Not Limited	1	Yes	010	2
11	B	00001011	00	Bad	00	Not Limited	1	Yes	011	3
12	C	00001100	00	Bad	00	Not Limited	1	Yes	100	4
13	D	00001101	00	Bad	00	Not Limited	1	Yes	101	5
14	E	00001110	00	Bad	00	Not Limited	1	Yes	110	6
15	F	00001111	00	Bad	00	Not Limited	1	Yes	111	7
16	10	00010000	00	Bad	01	Low Limited	0	No	000	0
17	11	00010001	00	Bad	01	Low Limited	0	No	001	1
18	12	00010010	00	Bad	01	Low Limited	0	No	010	2
19	13	00010011	00	Bad	01	Low Limited	0	No	011	3
20	14	00010100	00	Bad	01	Low Limited	0	No	100	4
21	15	00010101	00	Bad	01	Low Limited	0	No	101	5
22	16	00010110	00	Bad	01	Low Limited	0	No	110	6
23	17	00010111	00	Bad	01	Low Limited	0	No	111	7

Table 5 - HART PV, SV, TV, and FV Status Values

24	18	00011000	00	Bad	01	Low Limited	1	Yes	000	0
25	19	00011001	00	Bad	01	Low Limited	1	Yes	001	1
26	1A	00011010	00	Bad	01	Low Limited	1	Yes	010	2
27	1B	00011011	00	Bad	01	Low Limited	1	Yes	011	3
28	1C	00011100	00	Bad	01	Low Limited	1	Yes	100	4
29	1D	00011101	00	Bad	01	Low Limited	1	Yes	101	5
30	1E	00011110	00	Bad	01	Low Limited	1	Yes	110	6
31	1F	00011111	00	Bad	01	Low Limited	1	Yes	111	7
32	20	00100000	00	Bad	10	High Limited	0	No	000	0
33	21	00100001	00	Bad	10	High Limited	0	No	001	1
34	22	00100010	00	Bad	10	High Limited	0	No	010	2
35	23	00100011	00	Bad	10	High Limited	0	No	011	3
36	24	00100100	00	Bad	10	High Limited	0	No	100	4
37	25	00100101	00	Bad	10	High Limited	0	No	101	5
38	26	00100110	00	Bad	10	High Limited	0	No	110	6
39	27	00100111	00	Bad	10	High Limited	0	No	111	7
40	28	00101000	00	Bad	10	High Limited	1	Yes	000	0
41	29	00101001	00	Bad	10	High Limited	1	Yes	001	1
42	2A	00101010	00	Bad	10	High Limited	1	Yes	010	2
43	2B	00101011	00	Bad	10	High Limited	1	Yes	011	3
44	2C	00101100	00	Bad	10	High Limited	1	Yes	100	4
45	2D	00101101	00	Bad	10	High Limited	1	Yes	101	5

Note that this Device Variable Status byte is a new HART feature in HART protocol revision 6 and many HART devices do not yet support it. For those devices, the module creates a status value based on the communication status of the device.

If the PV, SV, TV, FV are being collected without communication errors, the value is set to 16#C0, indicating Good, Not Limited. Otherwise, the value is set to 0, indicating Bad, Not Limited, no specific information available.

Notes:

Engineering Unit Code Numbers

Code Number Details

This table maps engineering unit code numbers to their meaning and abbreviations. These codes are used in the process variable range display.

Unit Codes	Description from HART Specification	Abbreviated Units
1	inches of water at 20 °C (68 °F)	inH2O (20 °C or 68 °F)
2	inches of mercury at 0 °C (32 °F)	inHg (0 °C or 32 °F)
3	feet of water at 20 °C (68 °F)	ftH2O (20 °C or 68 °F)
4	millimeters of water at 20 °C (68 °F)	mmH2O (20 °C or 68 °F)
5	millimeters of mercury at 0 °C (32 °F)	mmHg (0 °C or 32 °F)
6	pounds per square inch	psi
7	bars	bar
8	millibars	mbar
9	grams per square centimeter	g/square cm
10	kilograms per square centimeter	kg/square cm
11	pascals	Pa
12	kilopascals	kPa
13	torr	torr
14	atmospheres	atm
15	cubic feet per minute	cubic ft/min
16	gallons per minute	usg/min
17	liters per minute	L/min
18	imperial gallons per minute	impgal/min
19	cubic meter per hour	cubic m/h
20	feet per second	ft/s
21	meters per second	m/s
22	gallons per second	usg/s
23	million gallons per day	million usg/d
24	liters per second	L/s
25	million liters per day	ML/day
26	cubic feet per second	cubic ft/s
27	cubic feet per day	cubic ft/d
28	cubic meters per second	cubic m/s
29	cubic meters per day	cubic m/d
30	imperial gallons per hour	impgal/h
31	imperial gallons per day	impgal/d

Unit Codes	Description from HART Specification	Abbreviated Units
32	Degrees Celsius	°C
33	Degrees Fahrenheit	°F
34	Degrees Rankine	°R
35	Kelvin	°K
36	millivolts	mV
37	ohms	ohm
38	hertz	hz
39	milliamperes	mA
40	gallons	usg
41	liters	L
42	imperial gallons	impgal
43	cubic meters	cubic m
44	feet	ft
45	meters	m
46	barrels	bbl
47	inches	in
48	centimeters	cm
49	millimeters	mm
50	minutes	min
51	seconds	s
52	hours	h
53	days	d
54	centistokes	centistokes
55	centipoise	cP
56	microsiemens	microsiemens
57	percent	%
58	volts	V
59	pH	pH
60	grams	g
61	kilograms	kg
62	metric tons	t
63	pounds	lb
64	short tons	short ton
65	long tons	long ton
66	milli siemens per centimeter	millisiemens/cm
67	micro siemens per centimeter	microsiemens/cm
68	newton	N
69	newton meter	N m
70	grams per second	g/s
71	grams per minute	g/min

Unit Codes	Description from HART Specification	Abbreviated Units
72	grams per hour	g/h
73	kilograms per second	kg/s
74	kilograms per minute	kg/min
75	kilograms per hour	kg/h
76	kilograms per day	kg/d
77	metric tons per minute	t/min
78	metric tons per hour	t/h
79	metric tons per day	t/d
80	pounds per second	lb/s
81	pounds per minute	lb/min
82	pounds per hour	lb/h
83	pounds per day	lb/d
84	short tons per minute	short ton/min
85	short tons per hour	short ton/h
86	short tons per day	short ton/d
87	long tons per hour	long ton/h
88	long tons per day	long ton/d
89	deka therm	Dth
90	specific gravity units	specific gravity units
91	grams per cubic centimeter	g/cubic cm
92	kilograms per cubic meter	kg/cubic m
93	pounds per gallon	lb/usg
94	pounds per cubic feet	lb/cubic ft
95	grams per milliliter	g/mL
96	kilograms per liter	kg/L
97	grams per liter	g/L
98	pounds per cubic inch	lb/cubic in
99	short tons per cubic yard	short ton/cubic yd
100	degrees twaddell	°Tw
101	degrees brix	°Bx
102	degrees baume heavy	BH
103	degrees baume light	BL
104	degrees API	°API
105	percent solids per weight	% solid/weight
106	percent solids per volume	% solid/volume
107	degrees balling	degrees balling
108	proof per volume	proof/volume
109	proof per mass	proof/mass
110	bushels	bushel
111	cubic yards	cubic yd

Unit Codes	Description from HART Specification	Abbreviated Units
112	cubic feet	cubic ft
113	cubic inches	cubic in
114	inches per second	in/s
115	inches per minute	in/min
116	feet per minute	ft/min
117	degrees per second	°/s
118	revolutions per second	rev/s
119	revolutions per minute	rpm
120	meters per hour	m/hr
121	normal cubic meter per hour	normal cubic m/h
122	normal liter per hour	normal L/h
123	standard cubic feet per minute	standard cubic ft/min
124	bbl liq	bbl liq
125	ounce	oz
126	foot pound force	ft lb force
127	kilo watt	kW
128	kilo watt hour	kW h
129	horsepower	hp
130	cubic feet per hour	cubic ft/h
131	cubic meters per minute	cubic m/min
132	barrels per second	bbl/s
133	barrels per minute	bbl/min
134	barrels per hour	bbl/h
135	barrels per day	bbl/d
136	gallons per hour	usg/h
137	imperial gallons per second	impgal/s
138	liters per hour	L/h
139	parts per million	ppm
140	mega calorie per hour	Mcal/h
141	mega joule per hour	MJ/h
142	british thermal unit per hour	BTU/h
143	degrees	degrees
144	radian	rad
145	inches of water at 15.6 °C (60 °F)	inH2O (15.6 °C or 60 °F)
146	micrograms per liter	micrograms/L
147	micrograms per cubic meter	micrograms/cubic m
148	percent consistency	% consistency
149	volume percent	volume %
150	percent steam quality	% steam quality
151	feet in sixteenths	ft in sixteenths

Unit Codes	Description from HART Specification	Abbreviated Units
152	cubic feet per pound	cubic ft/lb
153	picofarads	pF
154	milliliters per liter	mL/L
155	microliters per liter	microliters/L
156	percent plato	% plato
157	percent lower explosion level	% lower explosion level
158	mega calorie	Mcal
159	Kilo-ohms	kohm
160	mega joule	MJ
161	british thermal unit	BTU
162	normal cubic meter	normal cubic m
163	normal liter	normal L
164	standard cubic feet	normal cubic ft
165	parts per billion	parts/billion
235	gallons per day	usg/d
236	hectoliters	hL
237	megapascals	MPa
238	inches of water at 4 °C (39.2 °F)	inH2O (4 °C or 39.2 °F)
239	millimeters of water at 4 °C (39.2 °F)	mmH2O (4 °C or 39.2 °F)

Notes:

Rockwell Automation Support

Use these resources to access support information.

Technical Support Center	Find help with how-to videos, FAQs, chat, user forums, and product notification updates.	rok.auto/support
Knowledgebase	Access Knowledgebase articles.	rok.auto/knowledgebase
Local Technical Support Phone Numbers	Locate the telephone number for your country.	rok.auto/phonesupport
Literature Library	Find installation instructions, manuals, brochures, and technical data publications.	rok.auto/literature
Product Compatibility and Download Center (PCDC)	Get help determining how products interact, check features and capabilities, and find associated firmware.	rok.auto/pcdc

Documentation Feedback

Your comments help us serve your documentation needs better. If you have any suggestions on how to improve our content, complete the form at rok.auto/docfeedback.

Waste Electrical and Electronic Equipment (WEEE)



At the end of life, this equipment should be collected separately from any unsorted municipal waste.





Rockwell Automation maintains current product environmental information on its website at rok.auto/pec.

Allen-Bradley, CompactLogix, ControlLogix, expanding human possibility, FactoryTalk, Integrated Architecture, Kinetix, PanelView, Rockwell Automation, RSLinx, Studio 5000, Studio 5000 Logix Designer, and TechConnect are trademarks of Rockwell Automation, Inc.

EtherNet/IP is a trademark of ODVA, Inc.

Trademarks not belonging to Rockwell Automation are property of their respective companies.

Rockwell Otomasyon Ticaret A.Ş. Kar Plaza İş Merkezi E Blok Kat:6 34752, İçerenköy, İstanbul, Tel: +90 (216) 5698400 EEE Yönetmeliğine Uygundur

Connect with us.    

rockwellautomation.com ————— expanding **human possibility**[™]

AMERICAS: Rockwell Automation, 1201 South Second Street, Milwaukee, WI 53204-2496 USA, Tel: (1) 414.382.2000, Fax: (1) 414.382.4444

EUROPE/MIDDLE EAST/AFRICA: Rockwell Automation NV, Pegasus Park, De Kleetlaan 12a, 1831 Diegem, Belgium, Tel: (32) 2 663 0600, Fax: (32) 2 663 0640

ASIA PACIFIC: Rockwell Automation, Level 14, Core F, Cyberport 3, 100 Cyberport Road, Hong Kong, Tel: (852) 2887 4788, Fax: (852) 2508 1846